

Date rev. Description

V 1.0

House Big Lauren 70 ISO

Sheet 1a

Drawing 3D

Scale

Material 70x135

Date 18.10.2017

Drawer K.K.

File Big Lauren 70 ISO 3D.dwg

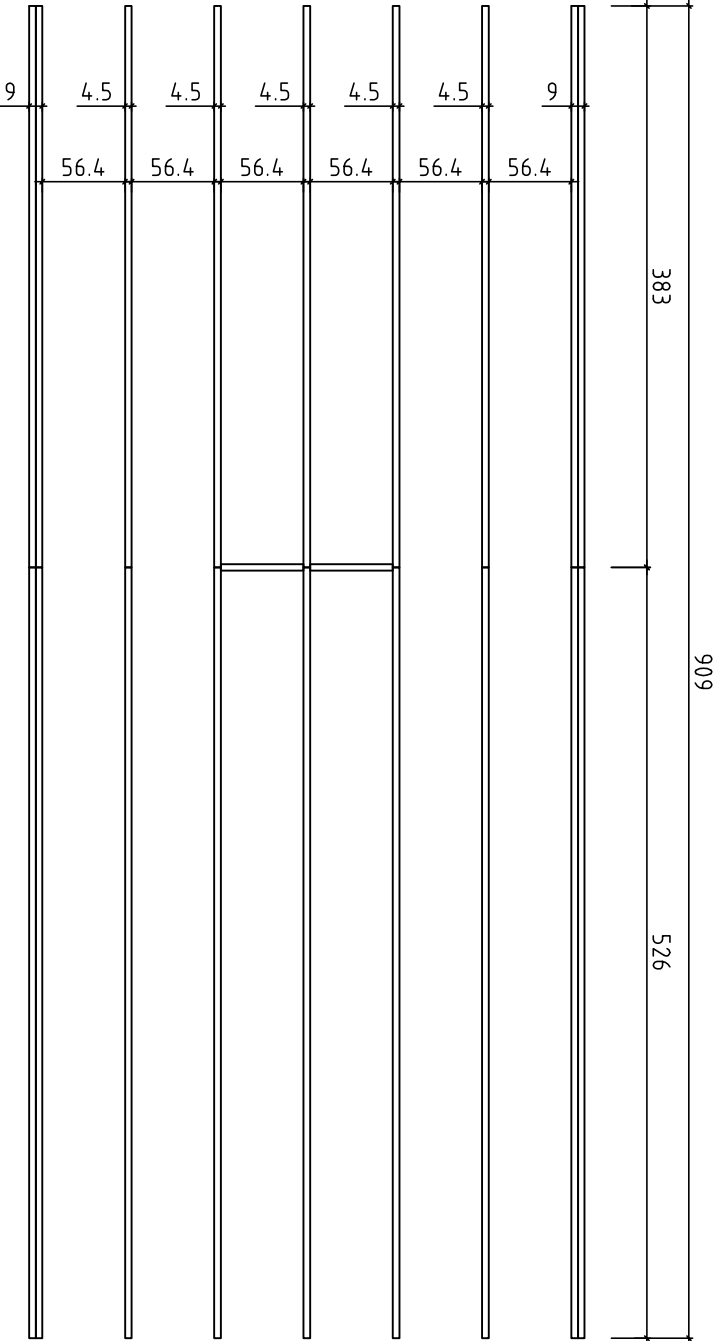

House	Big Lauren 70 ISO	Sheet	2
Drawing	FLOORBEAMS-FUSSBODENBALKEN-ALAOHJAUSPUUT	Scale	1:50
Material	4,5X70	Date	17.10.2017
Drawer	K.K.	File	Big Lauren 70 ISO.dwg

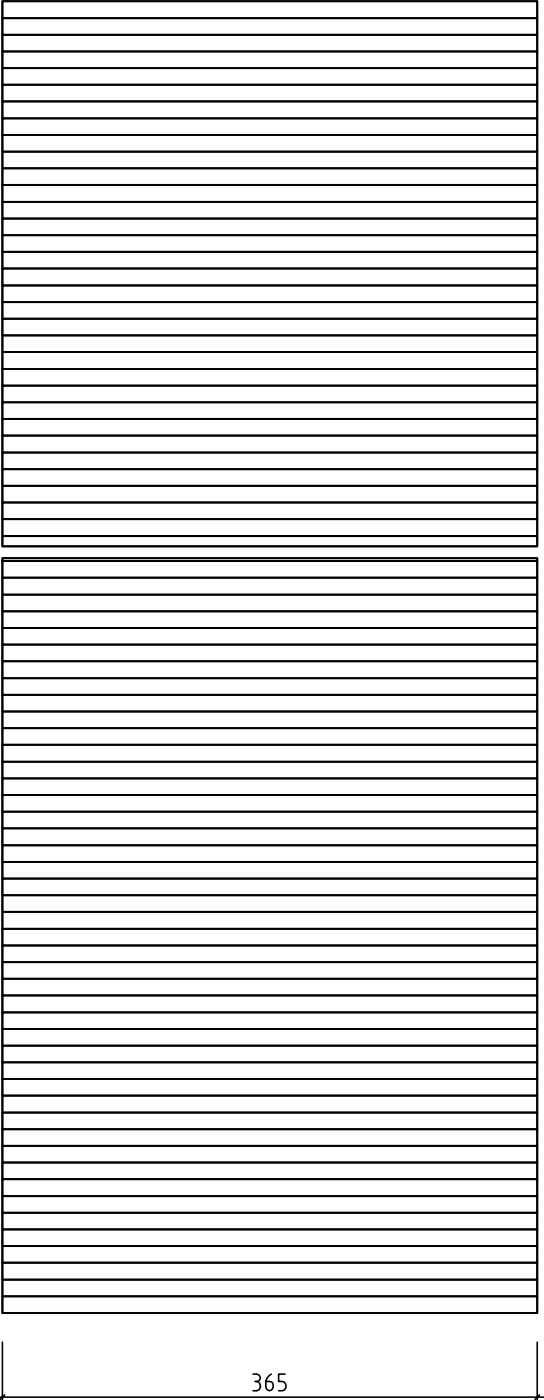

House	Big Lauren 70 ISO	Sheet	3
Drawing	Plan	Scale	1:50
Material	28X...	Date	17.10.2017
Drawer	K.K.	File	Big Lauren 70 ISO.dwg

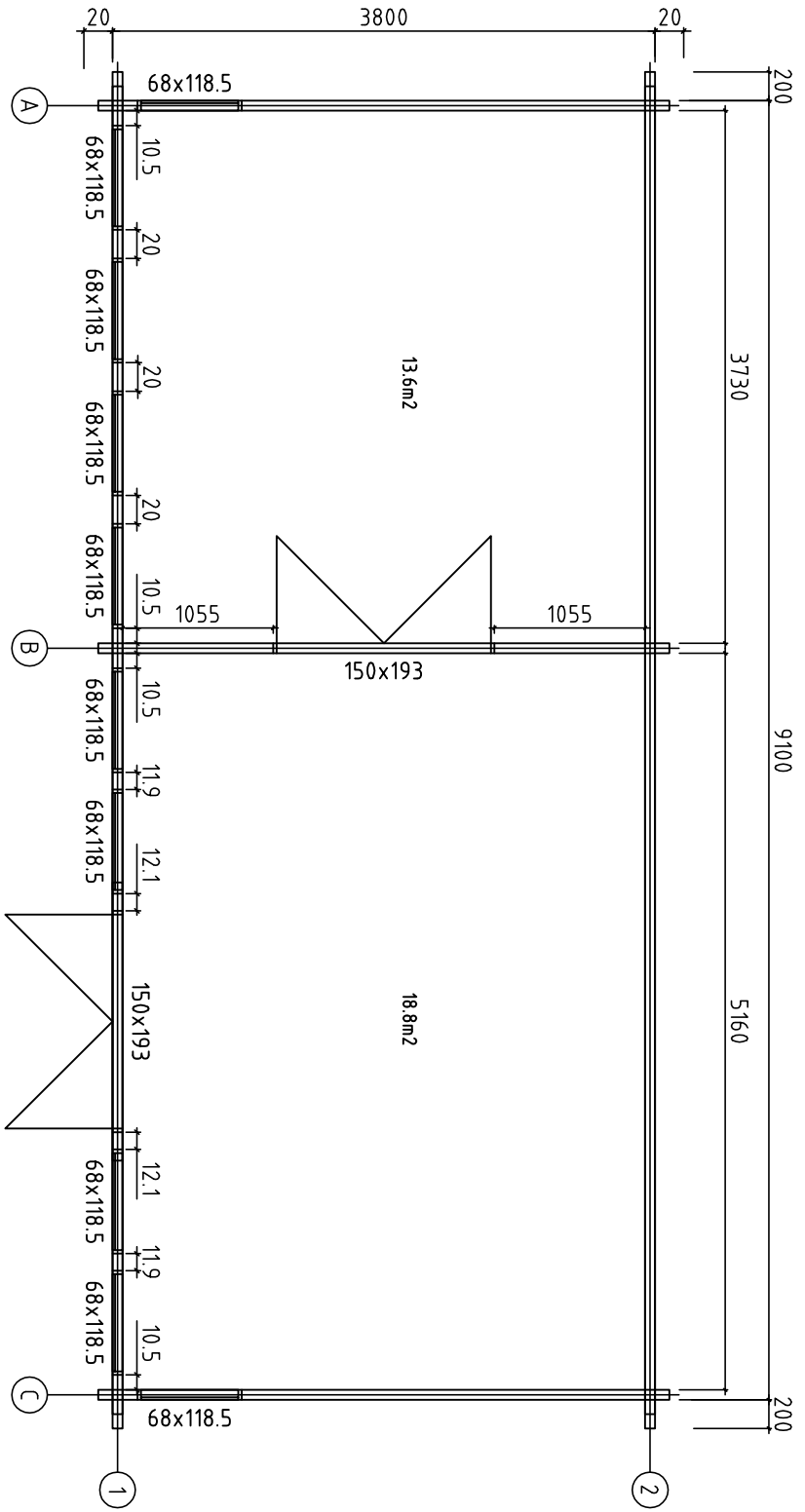

House	Big Lauren 70 ISO	Sheet	4
Drawing	Plan	Scale	1:50
Material	70x135	Date	17.10.2017
Drawer	K.K.	File	Big Lauren 70 ISO.dwg

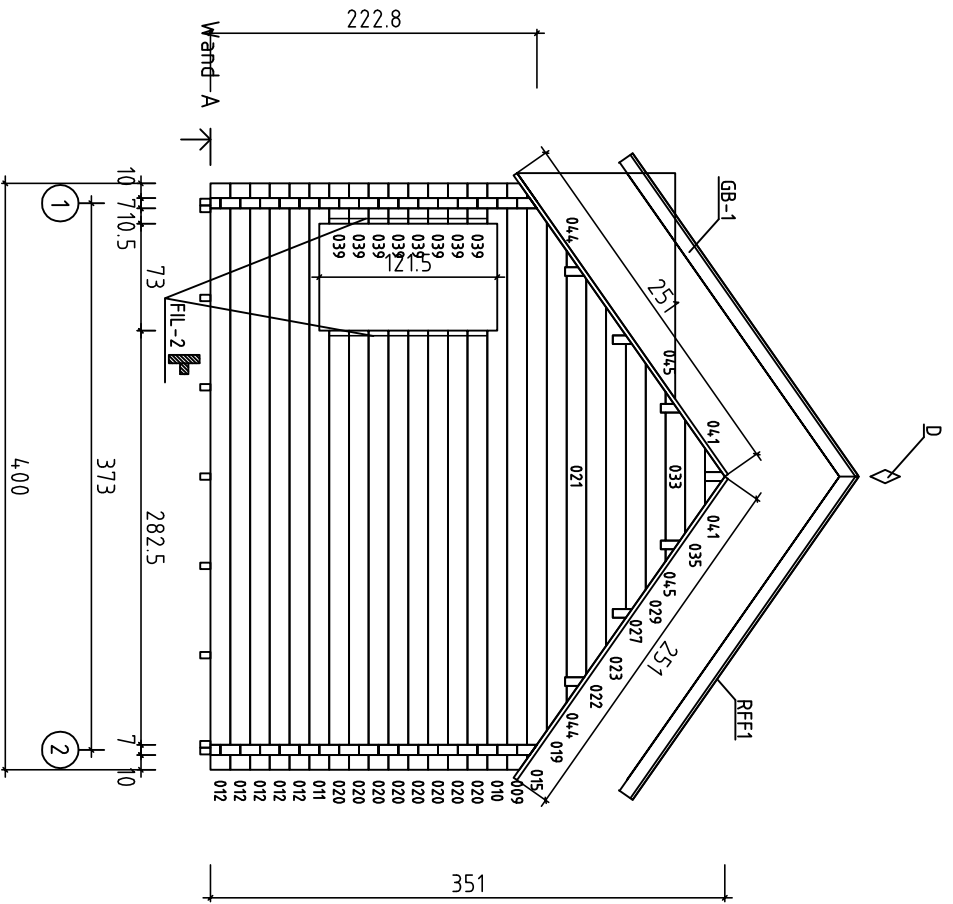

House	Big Lauren 70 ISO	Sheet	5
Drawing	WAND A	Scale	1:50
Material	7.0x13.5	Date	17.10.2017
Drawer	K.K.	File	Big Lauren 70 ISO.dwg

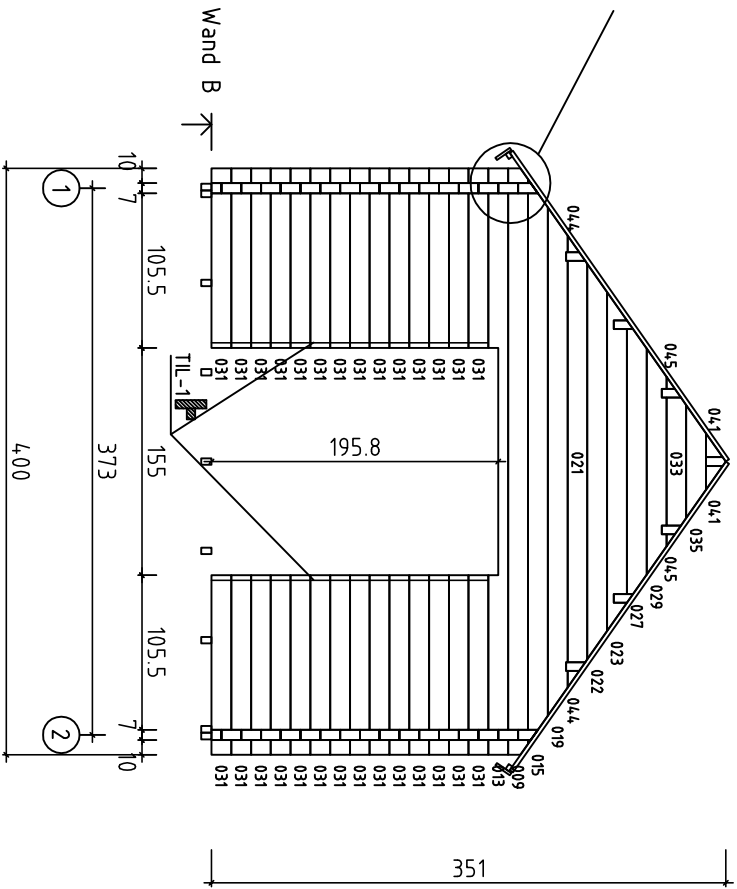
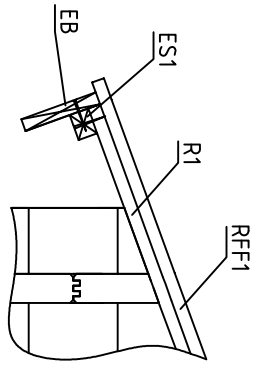

House	Big Lauren 70 ISO	Sheet	6
Drawing	WAND B	Scale	1:50
Material	7.0x13.5	Date	17.10.2017
Drawer	K.K.	File	Big Lauren 70 ISO.dwg



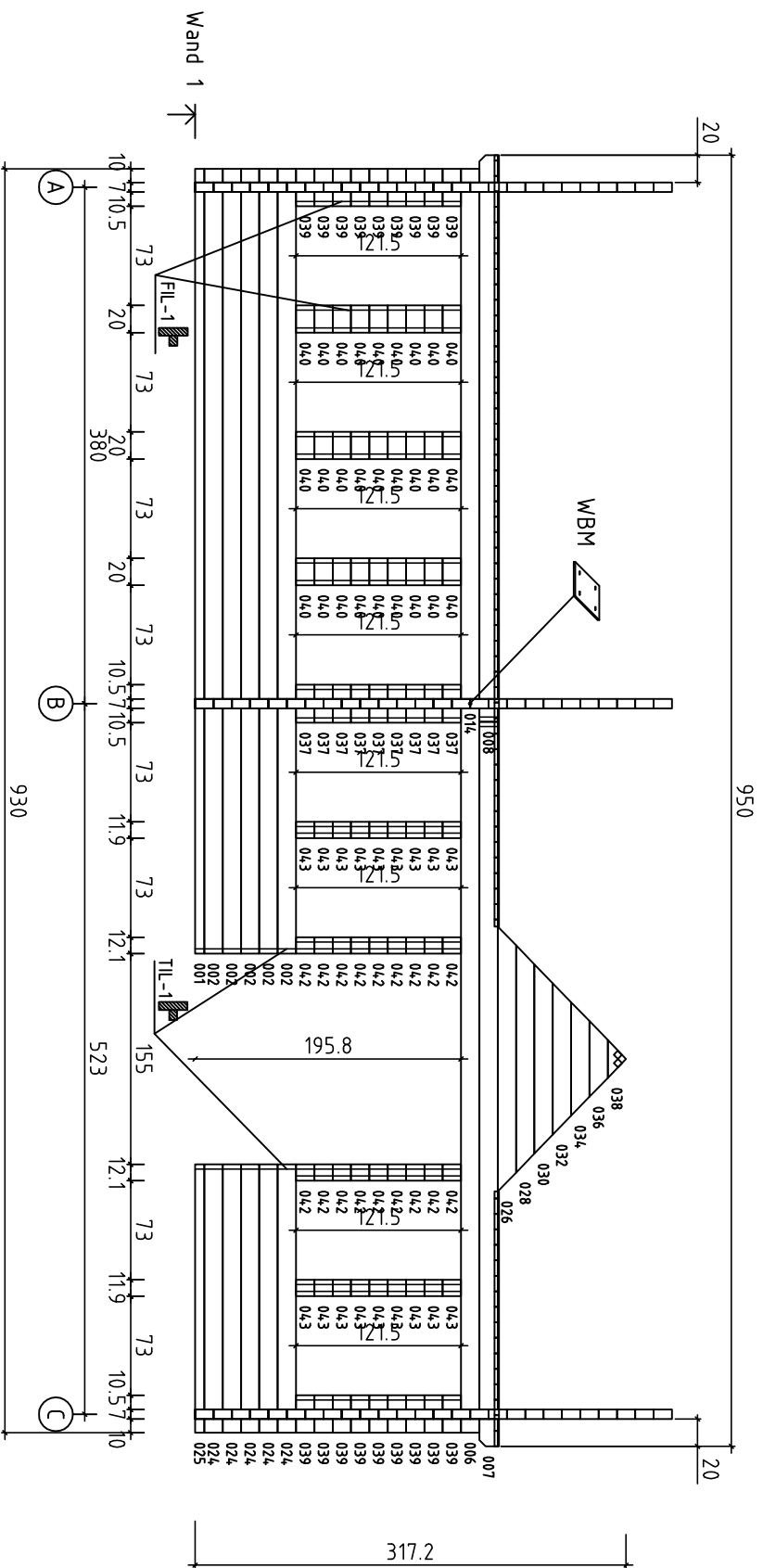

House	Big Lauren 70 ISO	Sheet	8
Drawing	WAND 1	Scale	1:50
Material	7.0x13.5	Date	17.10.2017
Drawer	K.K.	File	Big Lauren 70 ISO.dwg



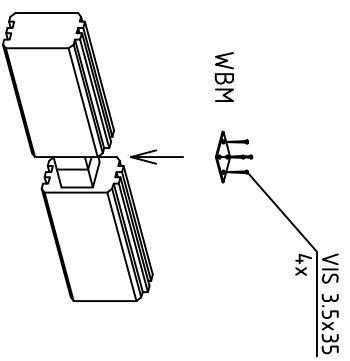
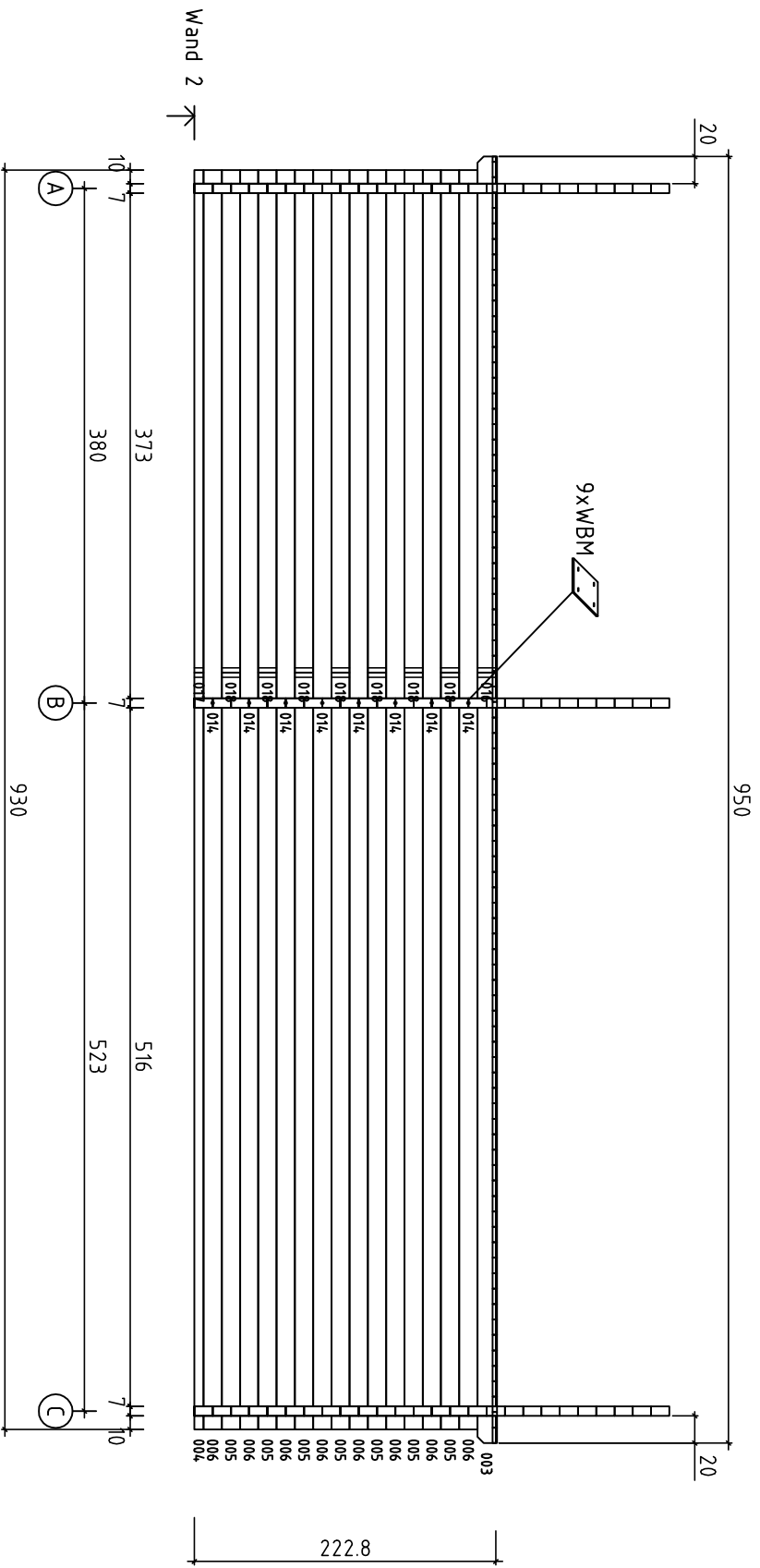



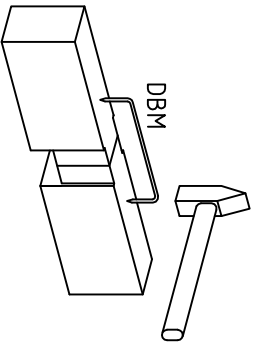
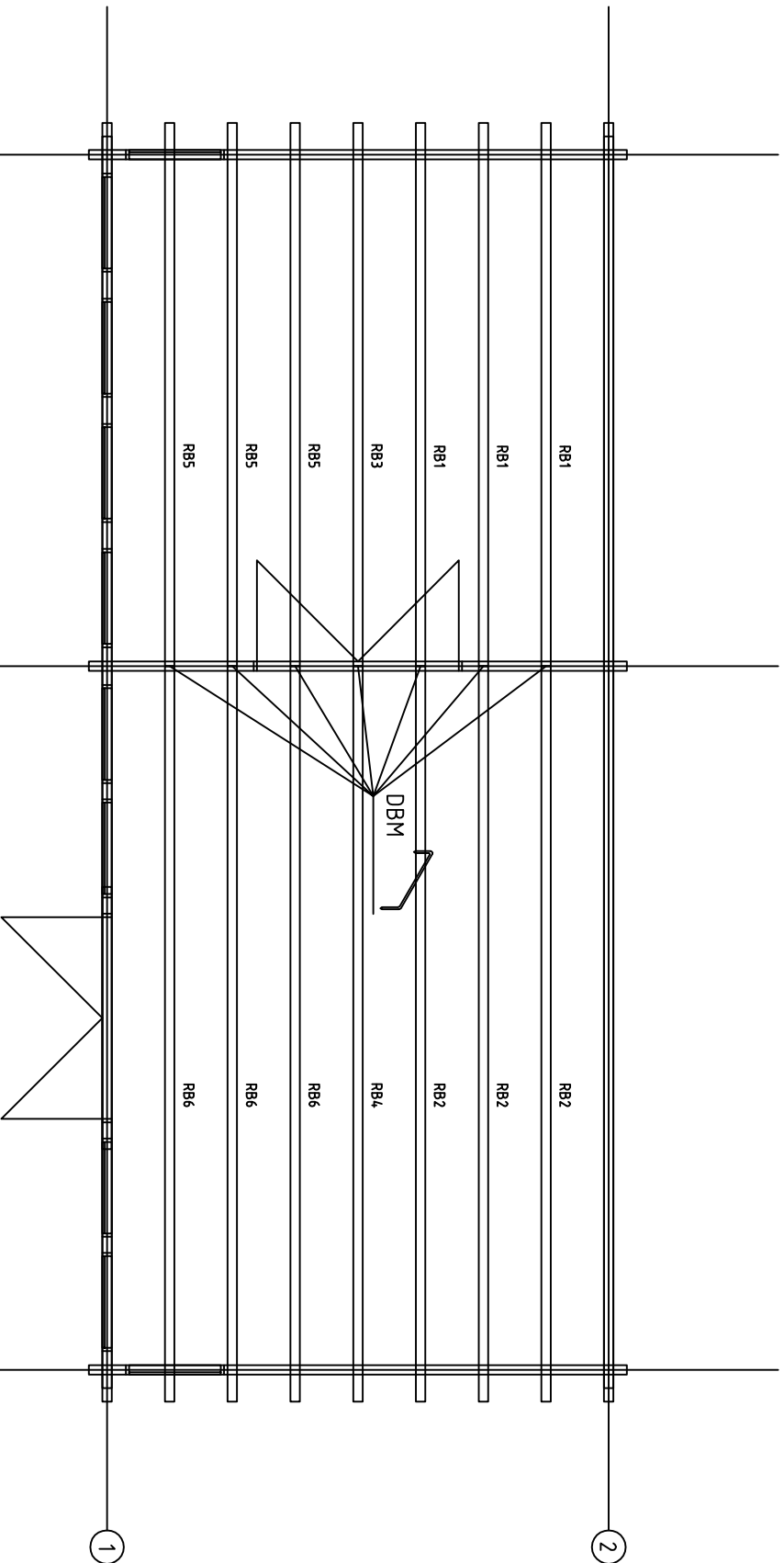

House	Big Lauren 70 ISO	Sheet	9
Drawing	WAND 2	Scale	1:50
Material	7.0x13.5	Date	17.10.2017
Drawer	K.K.	File	Big Lauren 70 ISO.dwg



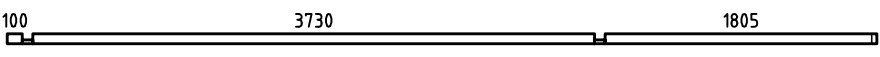
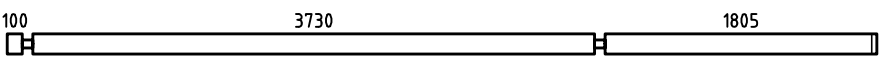
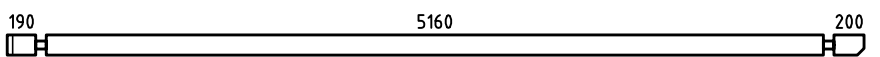
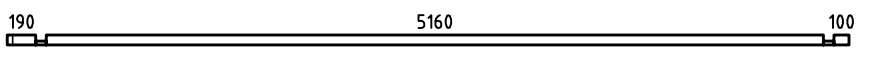
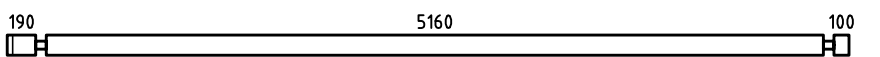
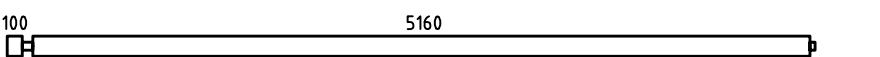

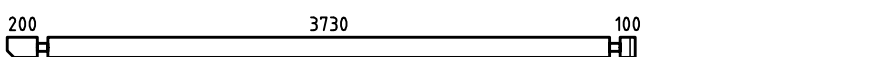
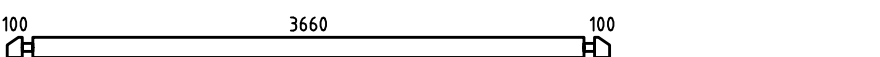
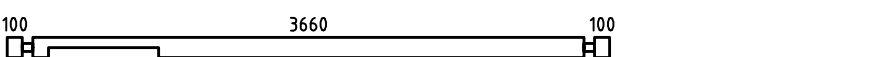
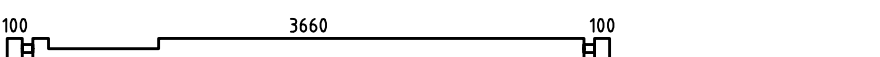
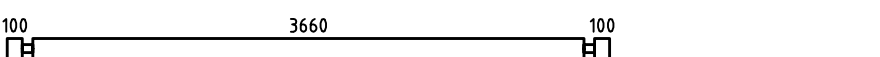
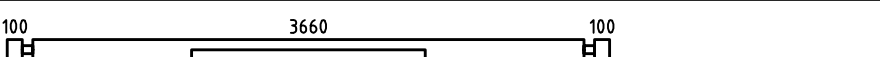
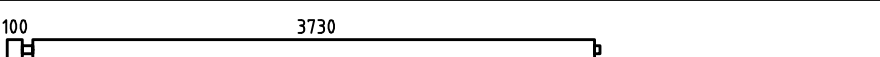
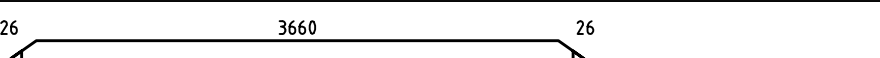
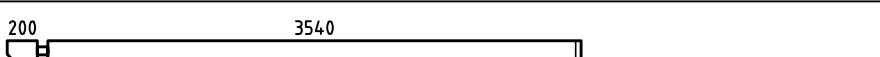
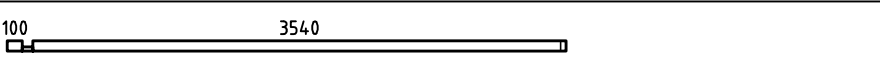
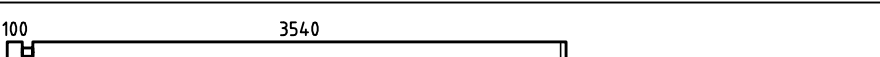
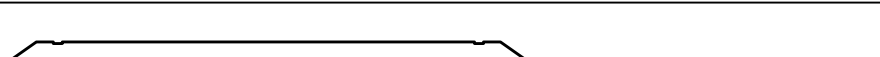
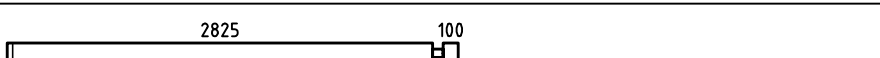
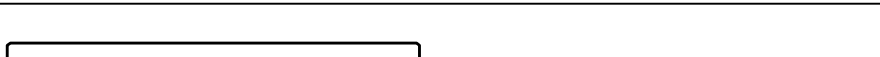
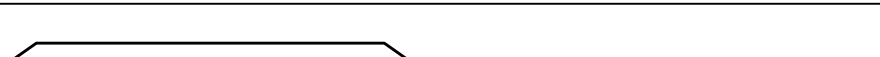
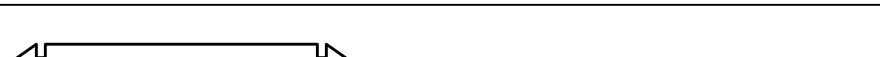
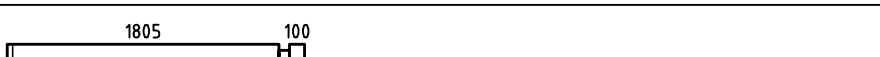





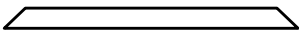
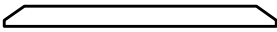
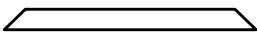
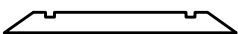
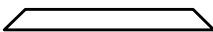
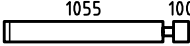

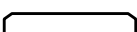
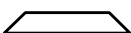
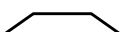



House	Big Lauren 70 ISO	Sheet	10
Drawing	ROOFBEAMS-DACHBALKEN-DAKBALKEN	Scale	1:50
Material	70x140	Date	17.10.2017
Drawer	K.K.	File	Big Lauren 70 ISO.dwg







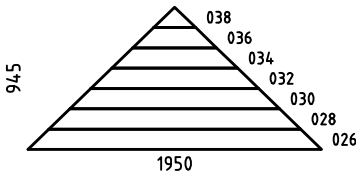

1.PAKK 600x120x77 2.PAKK 600x120x74 3.PAKK 600x120x72

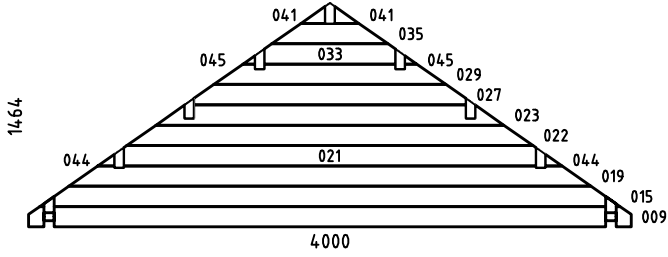
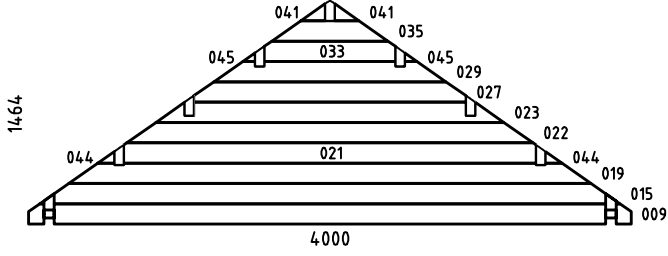
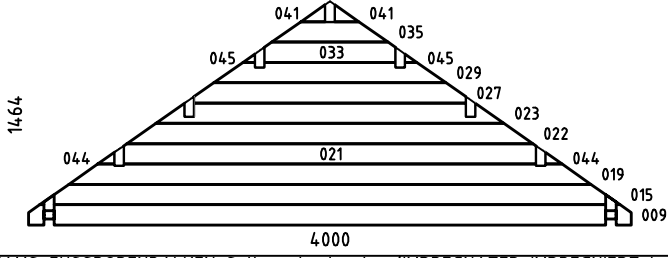
Pos	Big Lauren 70 ISO	Pcs.	Profil (mm)	L (mm)		
001		1	70x68	5775		
002		5	70x135	5775		
003		1	70x135	5690		
004		1	70x68	5590		
005		7	70x135	5590		
006		9	70x135	5365		
007		1	70x135	5330		
008		1	70x135	4170		
009		3	70x135	4000		
010		2	70x135	4000		
011		2	70x135	4000		
012		10	70x135	4000		
013		1	70x135	4000		
014		9	70x135	3935		
015		3	70x135	3853		
016		1	70x135	3810		
017		1	70x68	3710		
018		7	70x135	3710		
019		3	70x135	3467		
020		16	70x135	2995		
021		3	70x135	2738		
022		3	70x135	2697		
023		3	70x135	2312		
024		5	70x135	1975		
025		1	70x68	1975		
Kood	Big Lauren 70 ISO	Materjal	File	Big Lauren 70 ISO.dwg	Leht	11



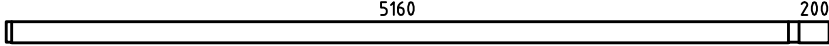
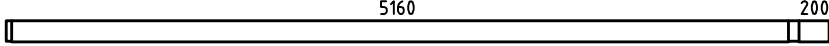
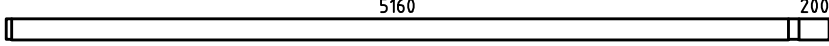
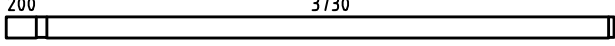
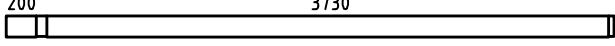
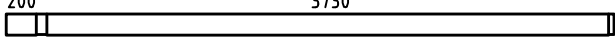















1.PAKK 600x120x77 2.PAKK 600x120x74 3.PAKK 600x120x72

Pos	Big Lauren 70 ISO	Pcs.	Profil (mm)	L (mm)		
026		1	70x135	1950		
027		3	70x135	1807		
028		1	70x135	1671		
029		3	70x135	1541		
030		1	70x135	1393		
031		28	70x135	1225		
032		1	70x135	1114		
033		3	70x135	873		
034		1	70x135	836		
035		3	70x135	771		
036		1	70x135	557		
037		9	70x135	280		
038		1	70x135	279		
039		34	70x135	275		
040		27	70x135	200		
041		6	70x114	163		
042		18	70x135	121		
043		18	70x135	119		
044		6	70x79	112		
045		6	70x57	82		
SB	SPARE BEAM-ERSATZBOHLE-MADRIER DE RESERVE 	1	70x135	5775		
SH	HIT BLOCK-SCHLAGHÖLZER-MADRIERS D'ASSEMBLAGE 	2	70x135	300		
W1-1		1	70x945	1950		
Kood	Big Lauren 70 ISO	Materjal	File	Big Lauren 70 ISO.dwg	Leht	12

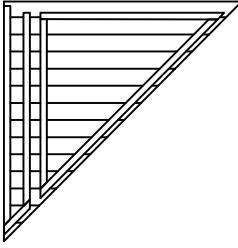
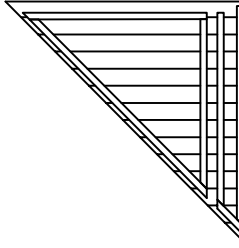
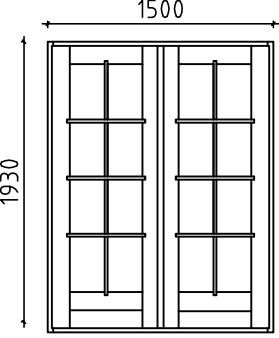
1.PAKK 600x120x77 2.PAKK 600x120x74 3.PAKK 600x120x72

Pos	Big Lauren 70 ISO	Pcs.	Profil (mm)	L (mm)		
WA-1		1	70x1460	4000		
WB-1		1	70x1460	4000		
WC-1		1	70x1460	4000		
FBI3	FLOORBEAMS-FUSSBODENBALKEN-Solives de plancher (IMPREGNATED-IMPREGNIERT-imprégnés) 	IMM	9 45x70	5260		
FBI2	FLOORBEAMS-FUSSBODENBALKEN-Solives de plancher (IMPREGNATED-IMPREGNIERT-imprégnés) 	IMM	9 45x70	3830		
FBI1	FLOORBEAMS-FUSSBODENBALKEN-Solives de plancher (IMPREGNATED-IMPREGNIERT-imprégnés) 	IMM	2 45x70	564		
RB6	ROOFBEAMS-DACHBALKEN-SOLIVES DE PLAFOND 	3	70x140	5465		
RB2	ROOFBEAMS-DACHBALKEN-SOLIVES DE PLAFOND 	3	70x140	5465		
RB4	ROOFBEAMS-DACHBALKEN-SOLIVES DE PLAFOND 	1	70x140	5465		
RB5	ROOFBEAMS-DACHBALKEN-SOLIVES DE PLAFOND 	3	70x140	4035		
RB1	ROOFBEAMS-DACHBALKEN-SOLIVES DE PLAFOND 	3	70x140	4035		
RB3	ROOFBEAMS-DACHBALKEN-SOLIVES DE PLAFOND 	1	70x140	4035		
	FLOORBOARDS-FUSSBODENBRETTER-PLANCHER  88mm or -oder-ou 114mm	103+1 79+1	28x88 28x114	3650		
R1	ROOFBOARD-DACHBRETTER-VOLIGES  88mm or -oder-ou 114mm	218+1 168+1	28x88 28x114	2510		
	SKIRTING SLAT-FUSSBODENLEISTE-BAGUETTE 		18x35	32.5		
GB1 GB2	GABLE BOARD-GIEBELBLENDE-PLANCHE DE RIVE	4 2	18x120	2680 1690		
EB	EAVE BOARD-TRAUFBRETT-LATTES SOUS VOLIGES 	4	18x90	4750		
Kood	Big Lauren 70 ISO	Materjal	File	Big Lauren 70 ISO.dwg	Leht	13

1.PAKK 600x120x77 2.PAKK 600x120x74 3.PAKK 600x120x72

Pos	Big Lauren 70 ISO		Pcs.	Profil (mm)	L (mm)	
ES1	EAVE SLAT-TRAUFENLEISTE- Baguettes pour fixer les lattes sous voliges		4	30x40	4750	
RFF1	ROOF FELT FILLET-GIEBELLEISTE- Baguettes pour fixer les planches de rive		4	18x70	2680	
RFF2	ROOF FELT FILLET-GIEBELLEISTE- Baguettes pour fixer les planches de rive		2	18x70	1690	
D	DIAMOND-RAUTE-ELEMENT DE DECORATION		3	18x90	200	
TIL-1	DOOR ASSEMBLING PROFILE-TÜR INSTALLIERUNGSPROFIL -Tasseau de fixation pour portes		4	43x70	1930	
FIL-1 FIL-2	WINDOW ASSEMBLING PROFILE-FENSTER INSTALLIERUNGSPROFIL -Tasseau de fixation pour fenêtres		16 4	43x70	1185 1050	
	STEEL CORNER-METALLVINKEL-Equerre de renfort	 FOR FLOORBEAMS FÜR FUSSBODENBALKEN Solives de plancher	4	40x40		
DBM	ROOFBEAMS CONNECTING METAL-DACHBALKEN BEFESTIGUNGSMETALLE- Connecteur métallique pour solives de plafond		7			
WBM	WALL FIXING PLATE-WANDBOHLLEN BEFESTIGUNGSMETALLE- PATTE D'ASSEMBLAGE		9	50	50	
SPJ	WALL FIXING SLAT-WANDBOHLLEN BEFESTIGUNG LEISTE- PATTE D'ASSEMBLAGE		10	19x50	120	
	NAILS-NÄGEL-CLOUS		30	2,5x60		
	SCREW-SCHRAUBEN-VIS		30	3,5x35		
			1+1	61x1591	1580	
	Doubledoor-Doppeltür-Double porte 1500x1930 - 2 pcs-st-unt (r-r-d) ISO  AST_PL		 P.P.  2  2  2  4  2	2	1500	1930
Kood	Big Lauren 70 ISO	Materjal	File	Big Lauren 70 ISO.dwg	Leht	14

1.PAKK 600x120x77 2.PAKK 600x120x74 3.PAKK 600x120x72

Pos	Big Lauren 70 ISO	Pcs.	Profil (mm)	L (mm)
	<p>WINDOW-FENSTER-Fenêtre 680x1185 10 pcs-st-unt (5 right-rechts-Droit) (5 left-links-Gauche) ISO</p>  <p>5V + 5P</p>	10	680	1185
Kood	Big Lauren 70 ISO	Materjal	File	Big Lauren 70 ISO.dwg
			Leht	15

