

House	Lulea 34	Sheet	1
Drawing	3D	Scale	
Material	34x135	Date	30.08.2019
Drawer	RP	File	Lulea 34_3D.dwg

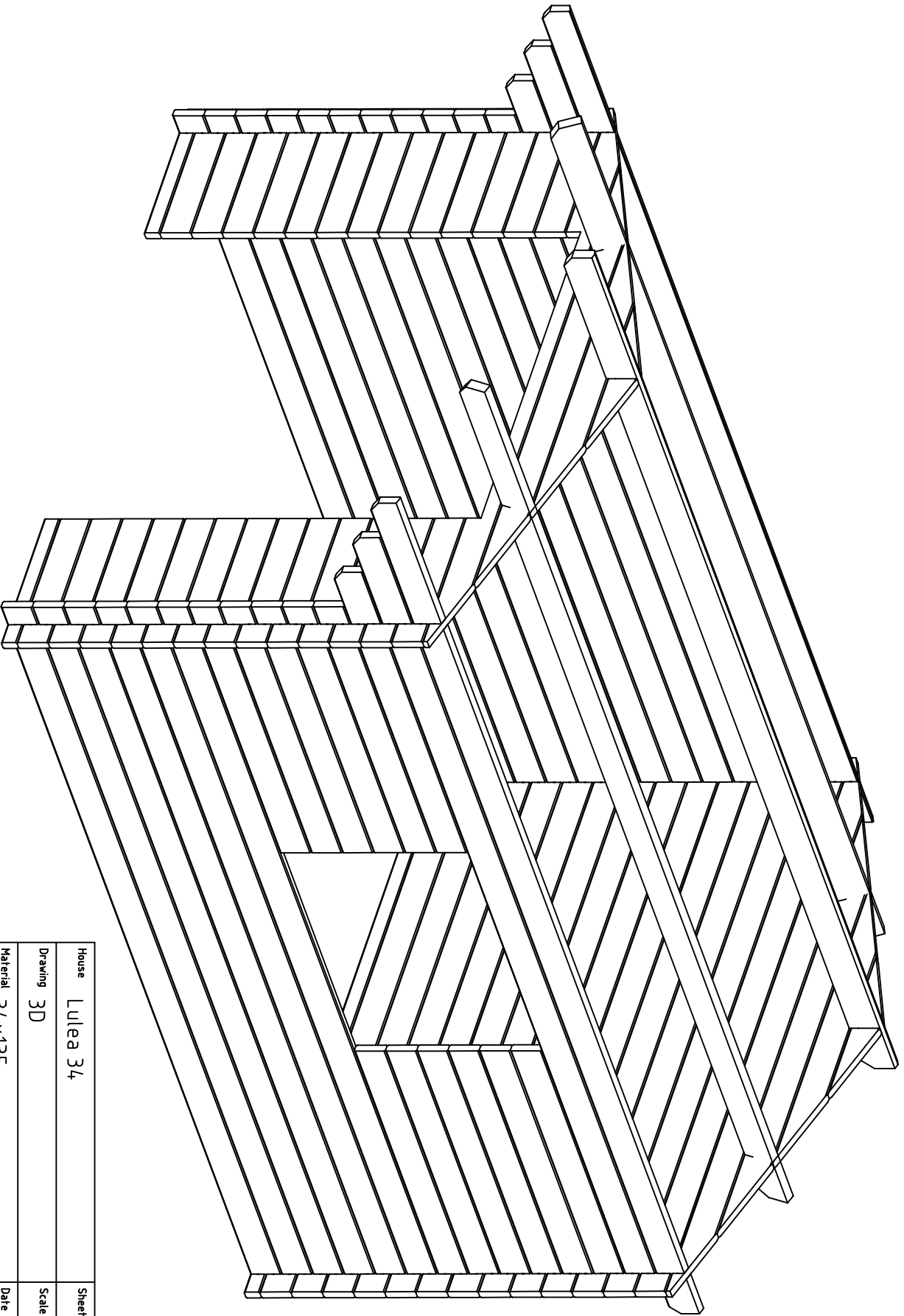

House	Luleå 34	Sheet	2
Drawing	3D	Scale	
Material	34x135	Date	30.08.2019
Drawer	RP	File	Luleå 34_3D.dwg

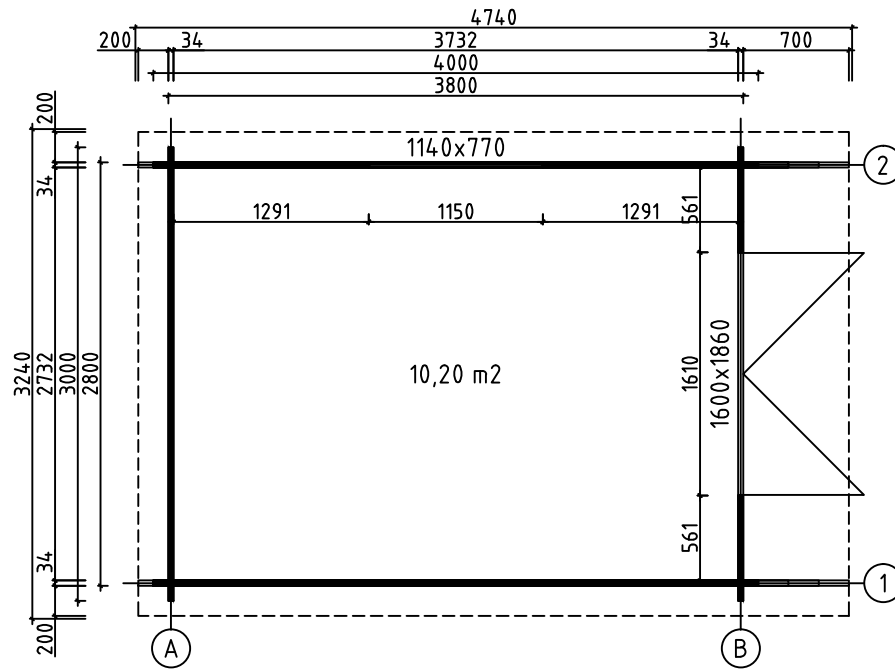

House	Lulea 34	Sheet	3
Drawing	GROUNDPLAN-GRUNDPLAN-PLAN	Scale	1:50
Material	34x135	Date	30.08.2019
Drawer	RP	File	Lulea 34.dwg

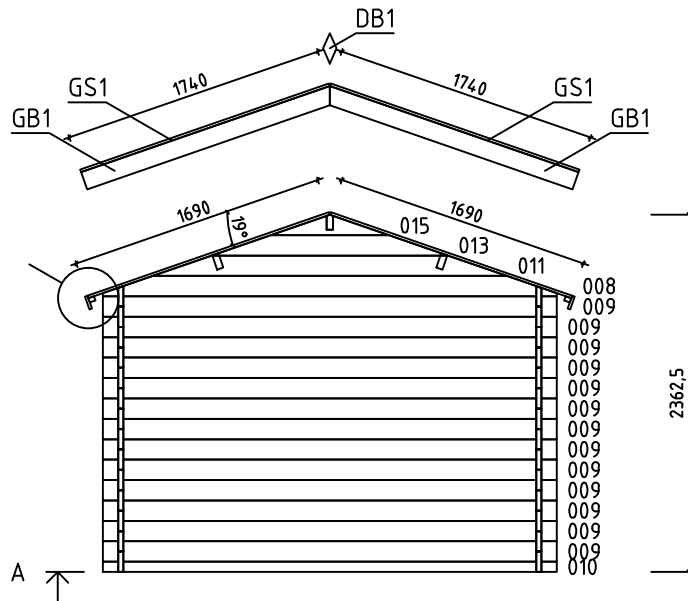
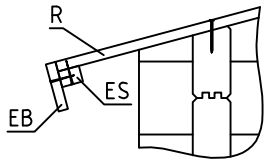

Wall-Wand-Muur A

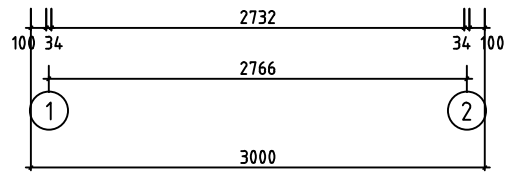

House	Lulea 34	Sheet	4
Drawing	WALL-WAND-MUUR A	Scale	1:50
Material	34x135	Date	30.08.2019
Drawer	RP	File	Lulea 34.dwg

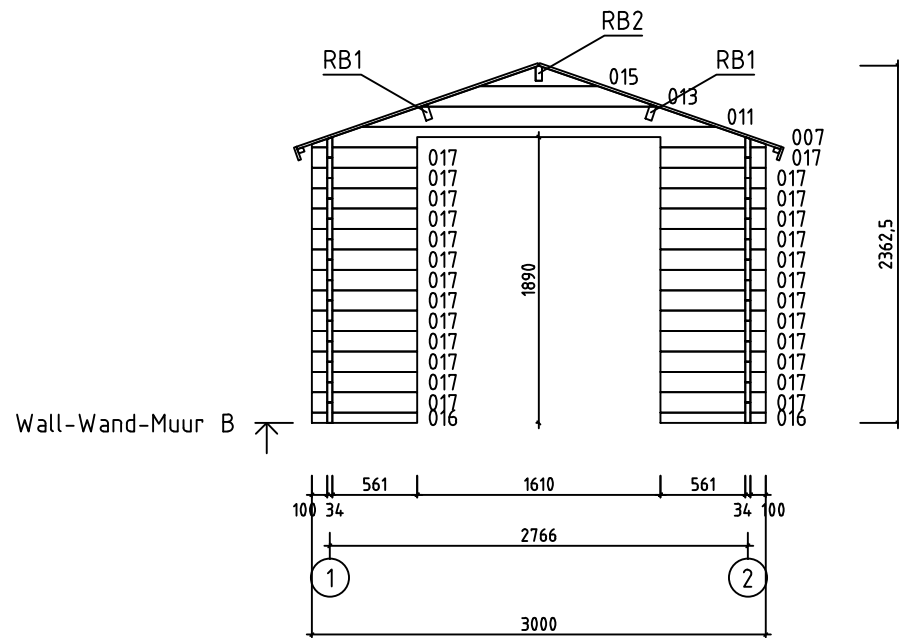

House	Lulea 34	Sheet	5
Drawing	WALL-WAND-MUUR B	Scale	1:50
Material	34x135	Date	30.08.2019
Drawer	RP	File	Lulea 34.dwg

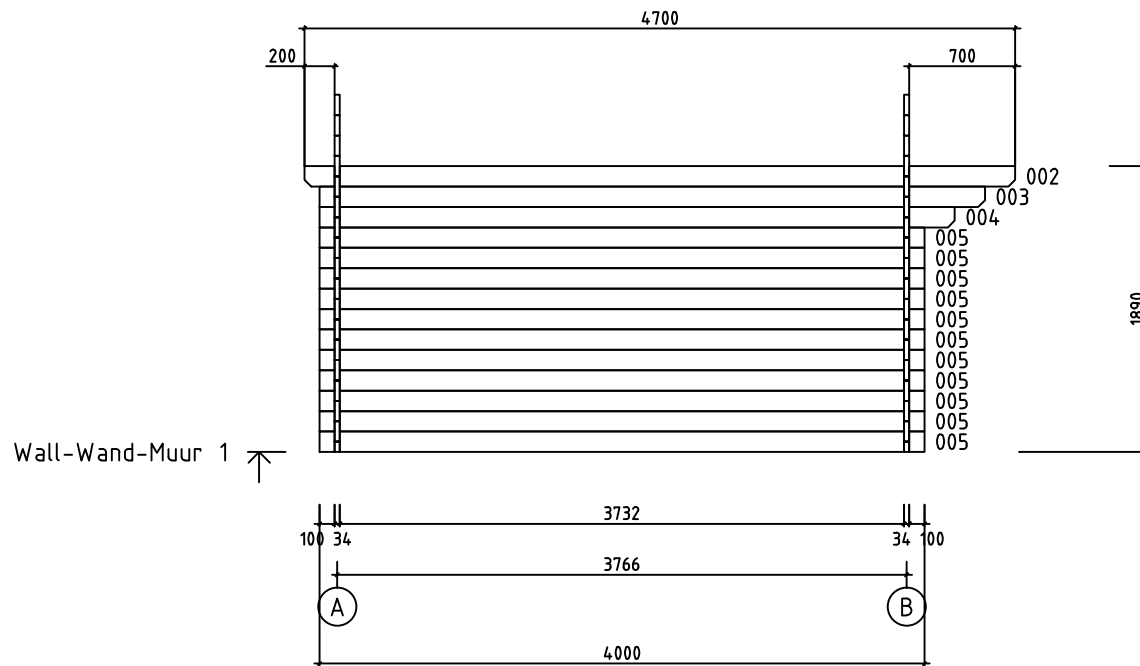



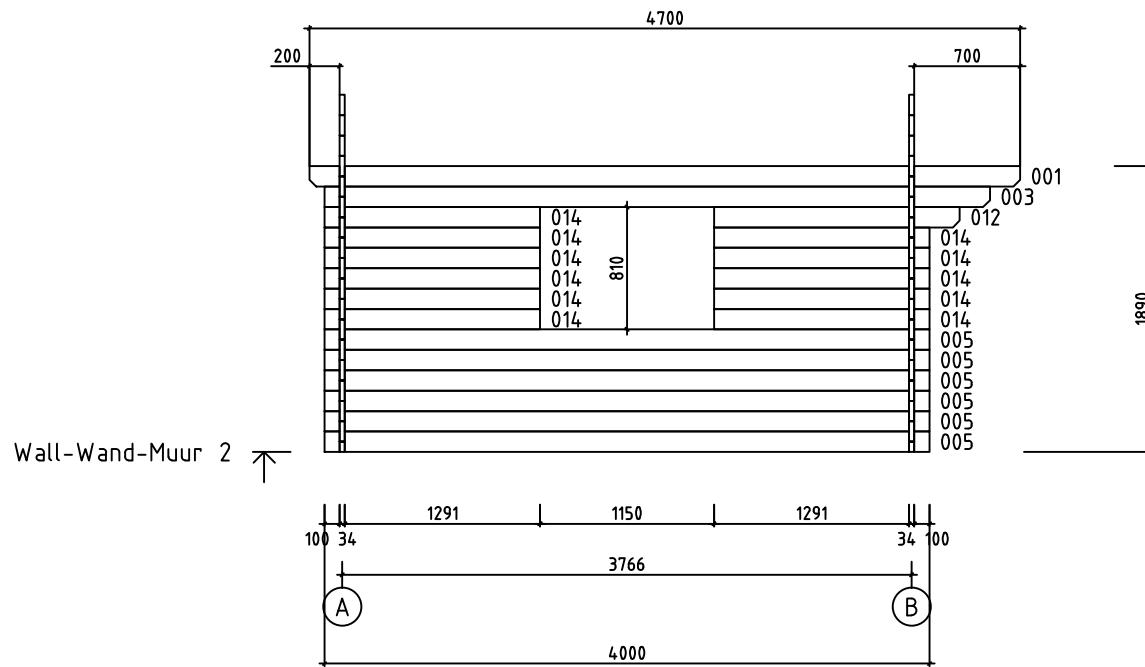



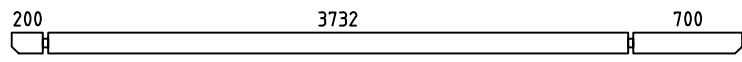
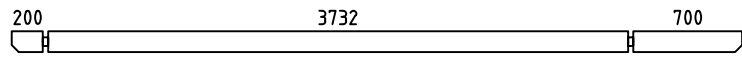
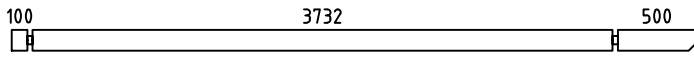
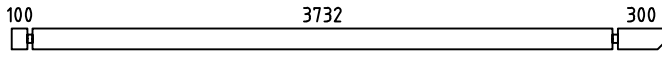
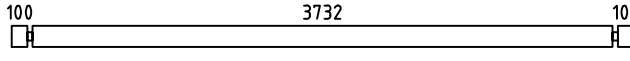
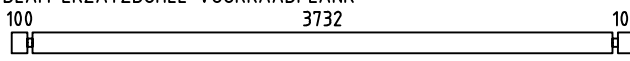
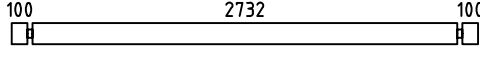
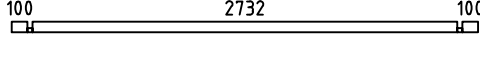
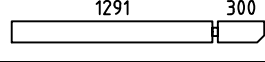
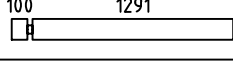
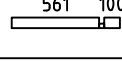
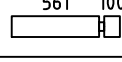
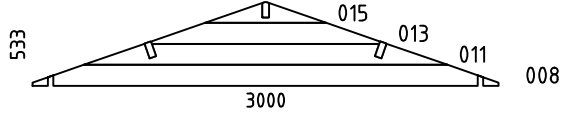
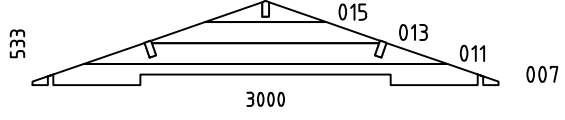

House	Lulea 34	Sheet	6
Drawing	WALL-WAND-MUUR 1	Scale	1:50
Material	34x135	Date	30.08.2019
Drawer	RP	File	Lulea 34.dwg

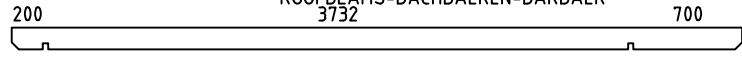
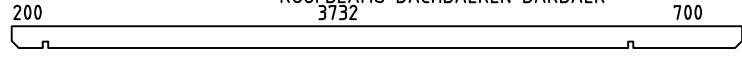

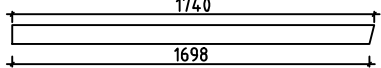
Wall-Wand-Muur 2 ↗

House	Lulea 34	Sheet	7
Drawing	WALL-WAND-MUUR 2	Scale	1:50
Material	34x135	Date	30.08.2019
Drawer	RP	File	Lulea 34.dwg

Pos	Specification-Bestimmung-Omschrijving	Pcs	Profile (mm)	L (mm)		
001		1	34x135	4700		
002		1	34x135	4700		
003		2	34x135	4400		
004		1	34x135	4200		
005		17	34x135	4000		
006	SPARE BEAM-ERZATZBOHLE-VOORRAADPLANK 	1	34x135	4000		
009		13	34x135	3000		
010		1	34x68	3000		
012		1	34x135	1625		
014		11	34x135	1425		
016		2	34x68	695		
017		26	34x135	695		
WA-1		1	34x533	2980		
WB-1		1	34x533	2980		
HB	HIT BLOCK-SCHLAGHÖLZER-BLAZENPLANK 	2	34x135	300		
RB1	ROOFBEAMS-DACHBALKEN-DAKBALK 	2	43x140	4700		
RB2	ROOFBEAMS-DACHBALKEN-DAKBALK 	1	43x140	4700		
R1	ROOFBOARD-DACHBRETT-DAKPLANK  or-oder-of	84+2 110+2	18x114 18x88	1690		
GB1	GABLE BOARD-GIEBELLENDE-GEVELPLANK 	4	18x120	1740		
GS1	ROOF FELT FILLET-GIEBELLEISTE-GEVELLIJST 	4	18x70	1740		
EB1	EAVE BOARD-TRAUFBRETT-AFDEKPLANK 	4	18x90	2350		
ES1	EAVE SLAT-TRAUFENLEISTE-AFDEKLIJST 	4	30x40	2350		
DB1	DIAMOND-RAUTE-DIAMANT 	2	18x90	200		
House	Lulea 34	Material	File	Lulea 34.dwg	Sheet	8

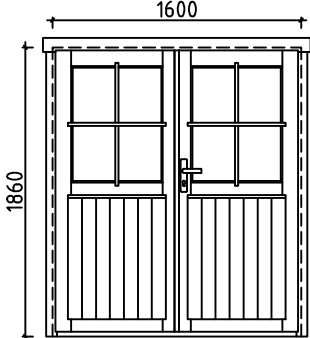
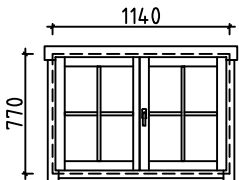
Pos	Specification-Bestimmung-Omschrijving	Pcs	Profile (mm)	L (mm)
	<p>DOUBLED OOR-DOPPEL TÜR-DUBBELE DEUR (right-rechts-rechts) AST_PL</p> 	<p>P</p> <p>1</p> <p>1</p> <p>1</p> <p>1</p> <p>6</p> <p>2</p>	<p>1600</p>	<p>1860</p>
	<p>DOUBLE WINDOW-DOPPEL FENSTER-DUBBELE VENSTER (right-rechts-rechts) AST_KP</p> 	<p>P</p> <p>1</p> <p>1</p> <p>2</p>	<p>1140</p>	<p>770</p>
House Lulea 34	Material	File Lulea 34.dwg	Sheet 9	

#001	2	4700	1
#002	1	4700	1
#003	1,2	4400	2
#004	1	4200	1
#005	1,2	4000	17
#006		4000	1
#007	B	3000	1
#008	A	3000	1
#009	A	3000	13
#010	A	3000	1
#011	A,B	2342	2
#012	2	1625	1
#013	A,B	1561	2
#014	2	1425	11
#015	A,B	781	2
#016	B	695	2
#017	B	695	26