

# Chappo28

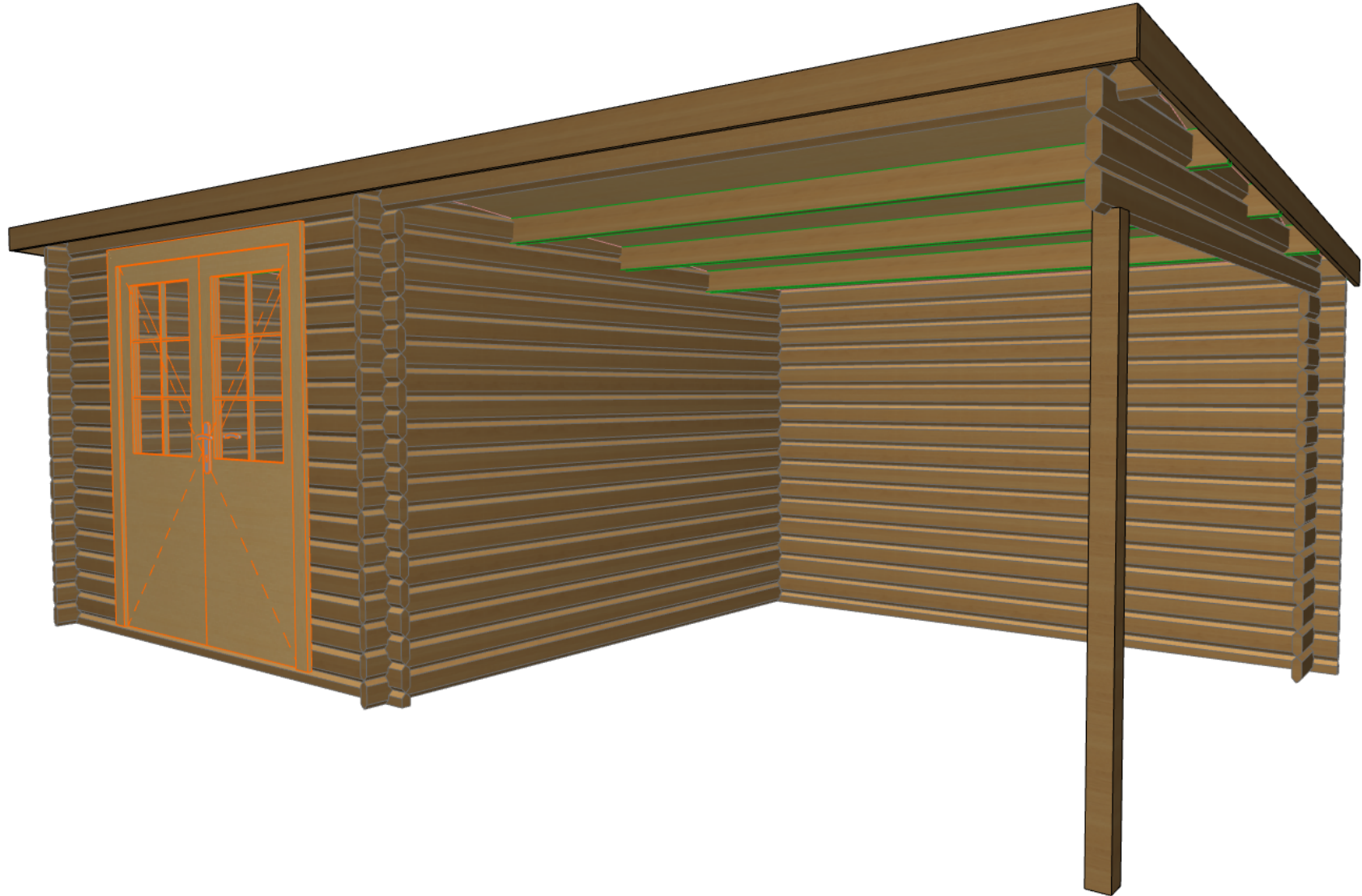

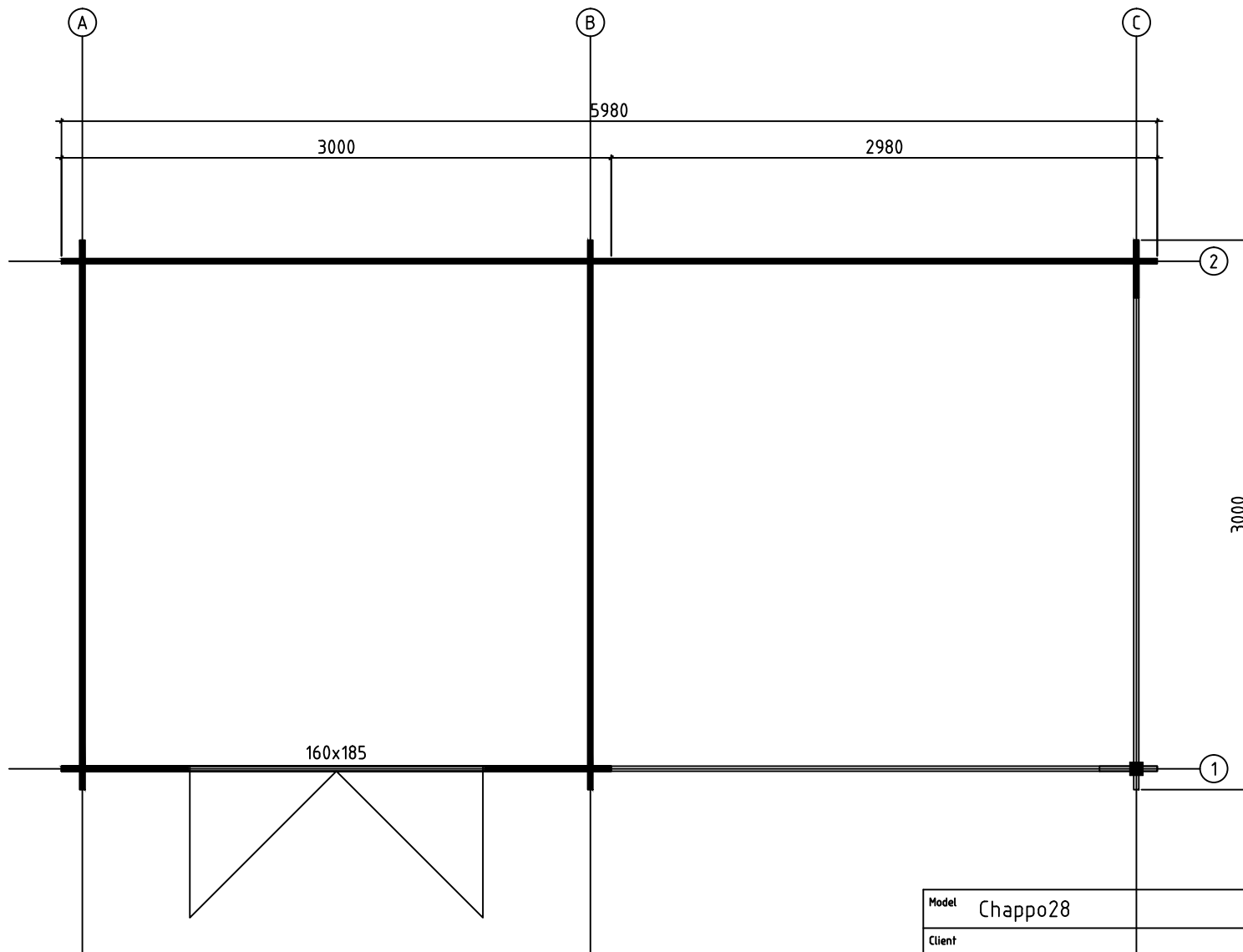

Model	Chappo28	Page	
Client		Scale	1:30
Material	28x114 mm	Date	09.01.2015
Company		File	Chappo28.dwg

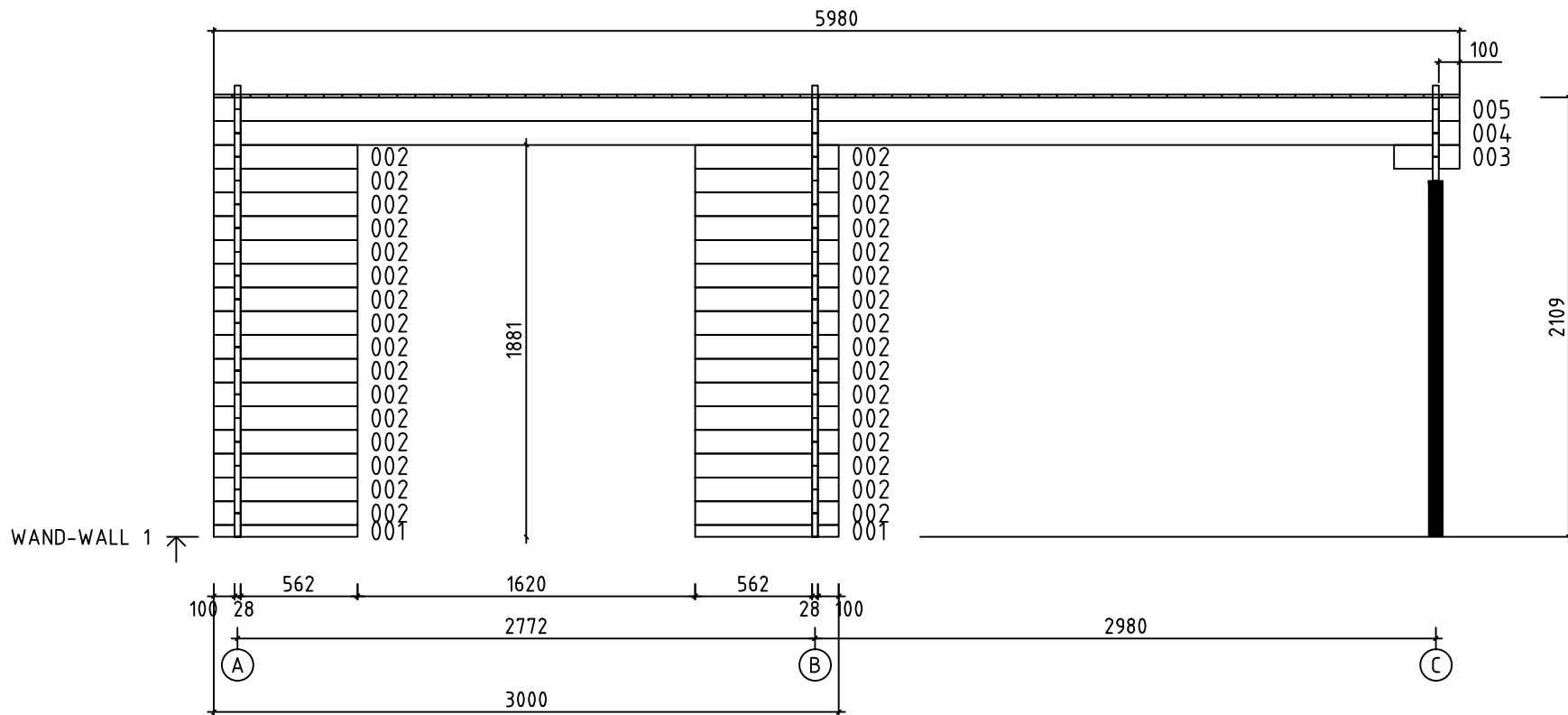

Model	Chappo28	Page	5
Client		Scale	1:30
Material	2.8x11.4	Date	09.01.2015
Company		File	Chappo28.dwg

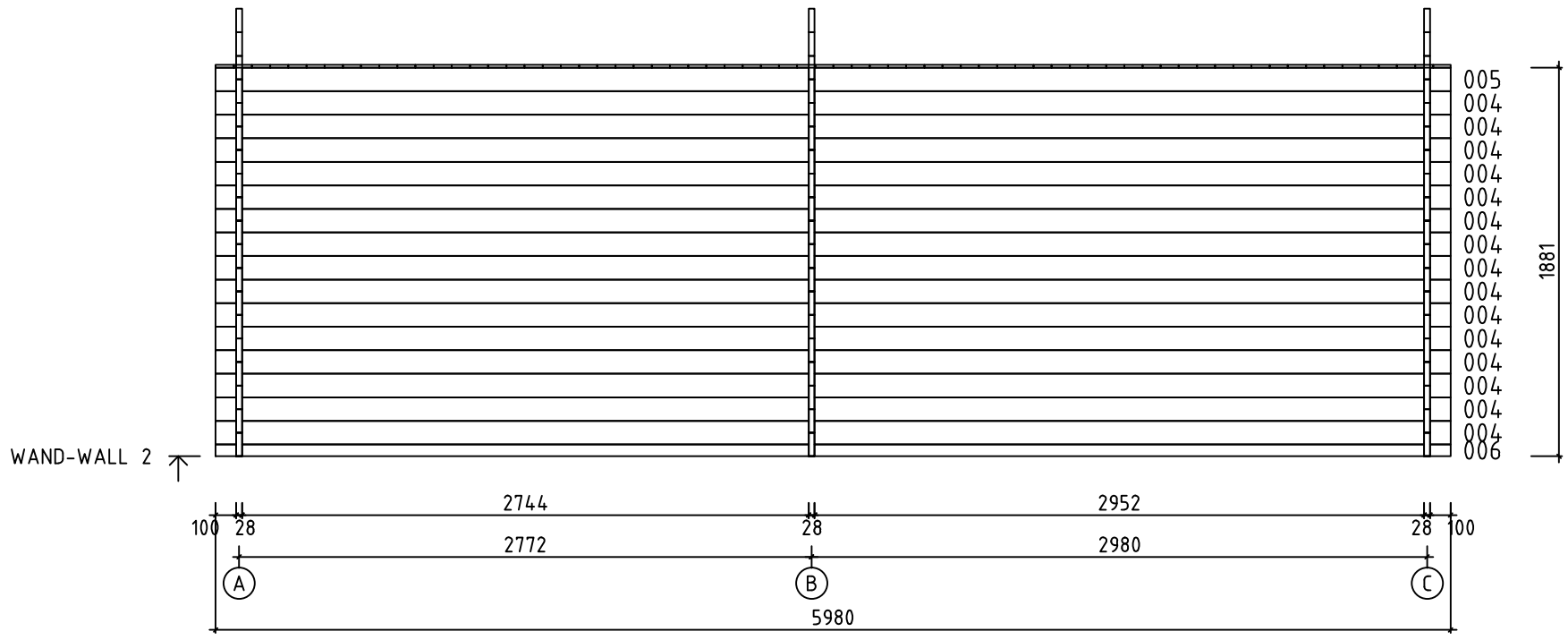

Model	Chappo28	Page	6
Client		Scale	1:30
Material	2.8x11.4	Date	09.01.2015
Company		File	Chappo28.dwg

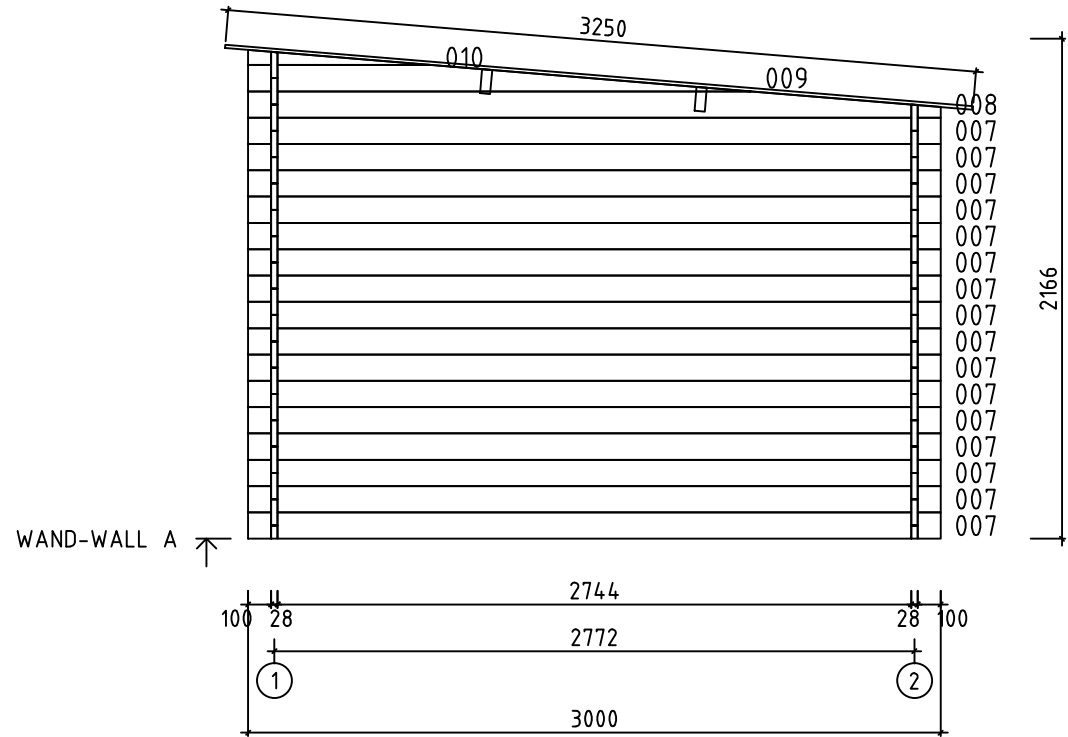



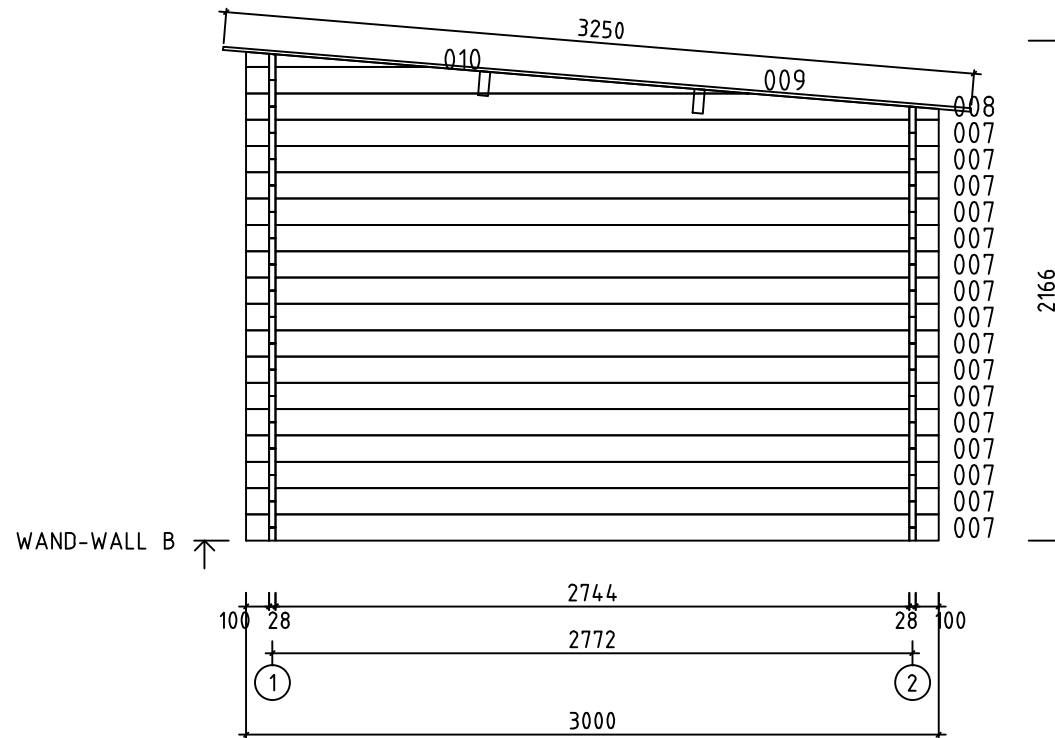



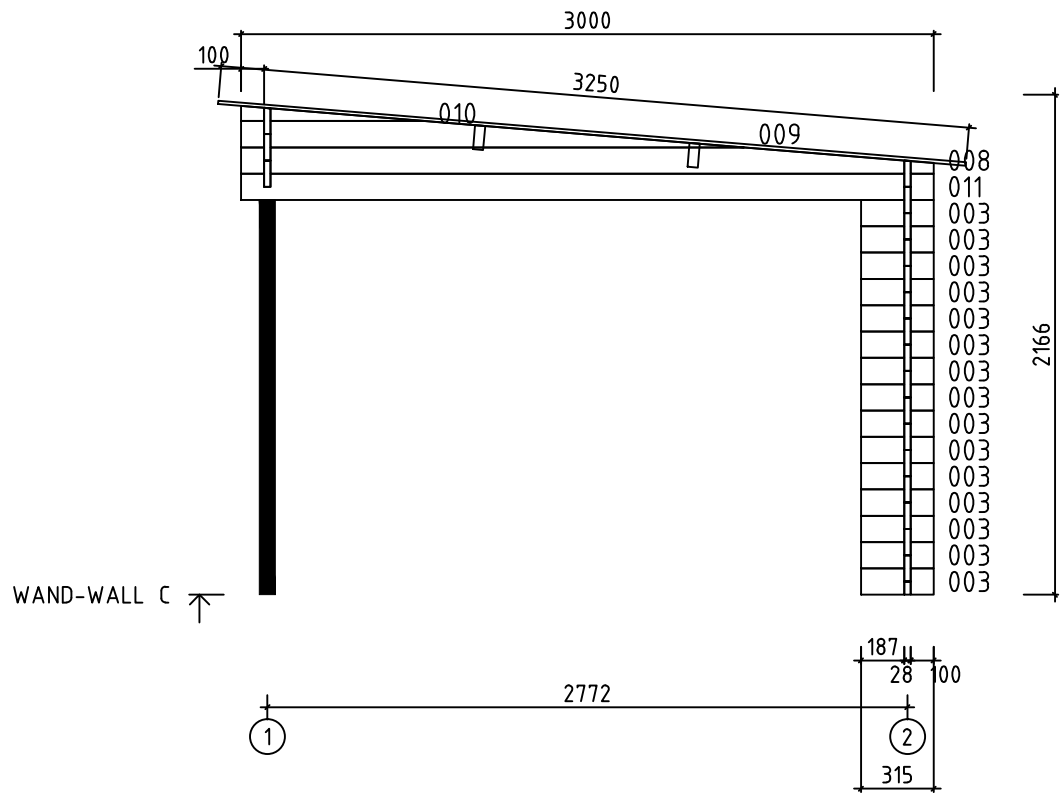

Model	Chappo28	Page	2
Client		Scale	1:30
Material	2.8x11.4	Date	09.01.2015
Company		File	Chappo28.dwg

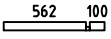
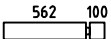

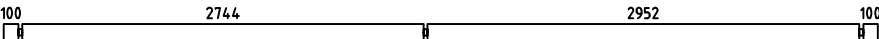
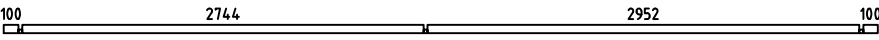
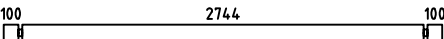
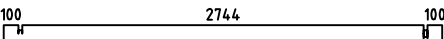
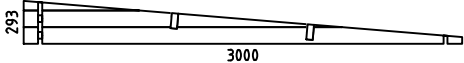
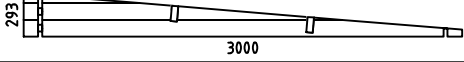
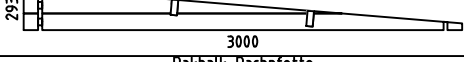
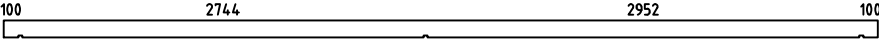
Model	Chappo28	Page	3
Client		Scale	1:30
Material	2.8x11.4	Date	09.01.2015
Company		File	Chappo28.dwg

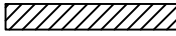

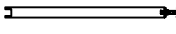
Model	Chappo28	Page	4
Client		Scale	1:30
Material	2.8x11.4	Date	09.01.2015
Company		File	Chappo28.dwg

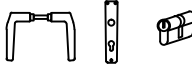
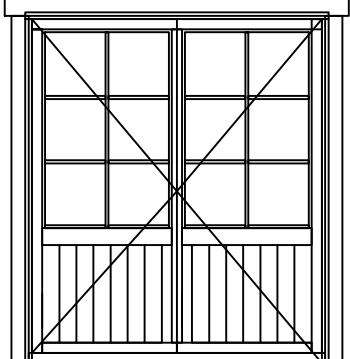
Pos	Omschrijving-Bestimmung-Specification	St.	Profiel (mm)	Length (mm)
001		2	28x57	690
002		32	28x114	690
003		16	28x114	315
004		16	28x114	5980
005		2	28x114	5980
006		1	28x57	5980
007		32	28x114	3000
011		1	28x114	3000
WA-1		1		
WB-1		1		
WC-1		1		
PR1		2	44x116	5980
DP1	Dakplank-Dachbrett 	68	88x15	3250
L2	Gevelplank-Giebelblende 	2	18x120	3290
L1	Leiste 	4	18x120	3008
	POST 70x70 	1		1710
	Schliessblech+Schrauben 3x25 2stück 	1		
	Türlinke+ Linkeplatte+ Zylinderschloss 	1		
DD6 28 W	DOOR 1600x1850 	1		
Kood	Materjal	File	Chappo28.dwg	Leht 1/1



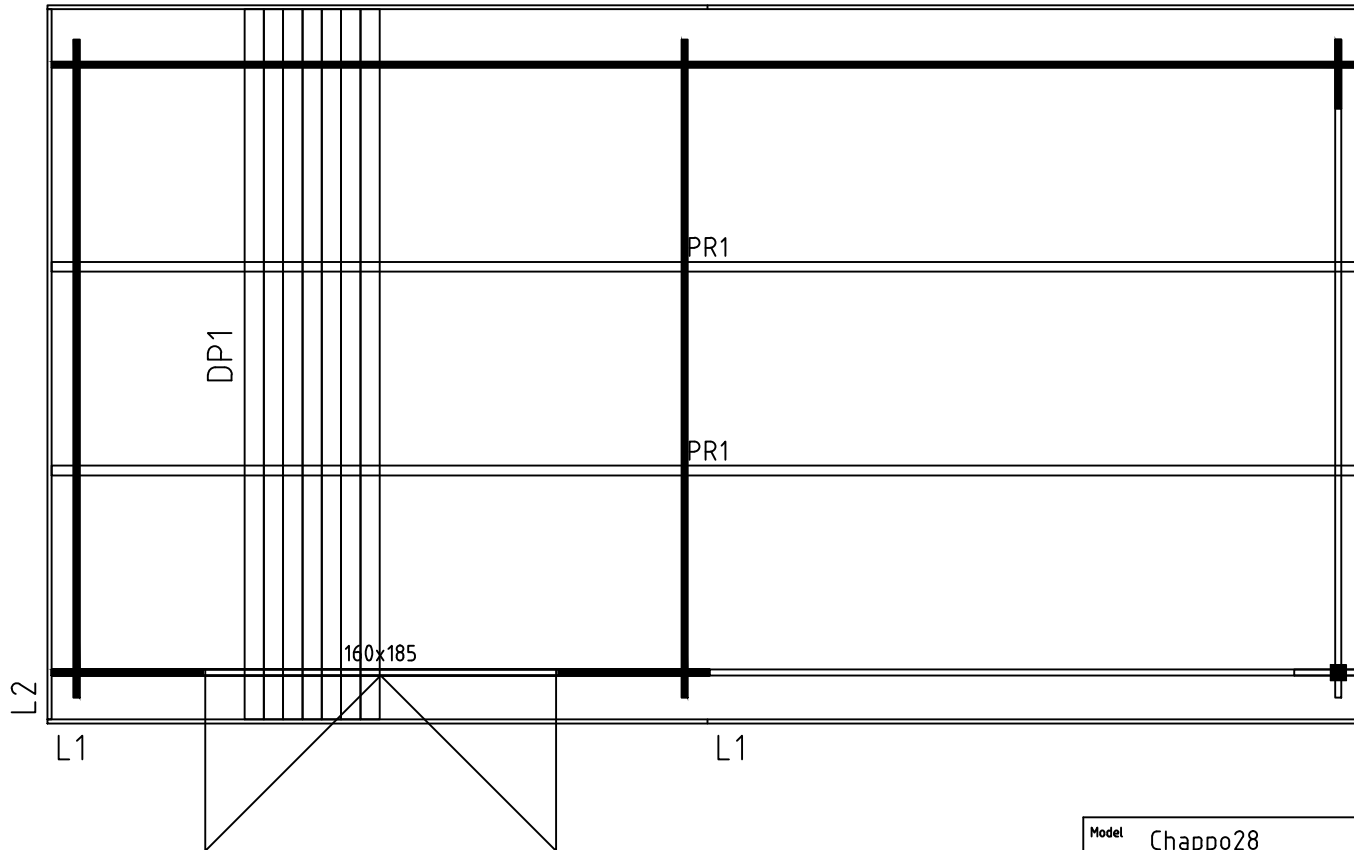
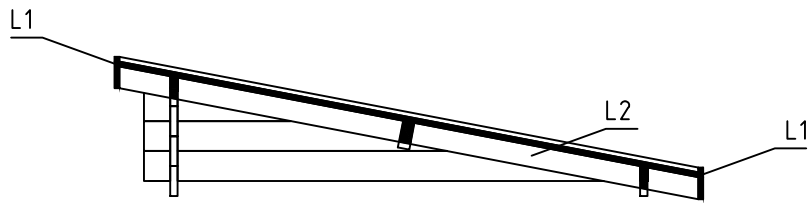

Model	Chappo28	Page	
Client		Scale	1:30
Material	28x114 mm	Date	09.01.2015
Company		File	Chappo28.dwg