

BUILDING CODE

# Anja

WALL LOG (mm): 28

SIZE (mm): 2950x2000

## COMPONENT SPECIFICATION

NUMBER	COMPONENT FUNCTION	COMPONENT CODE	VIEW	SIDE VIEW	DIMENSIONS (mm)			QUANTITY (psc.)
					LENGHT	WIDTH	THICKNESS	
1	Wall board	A2			670	115	28	16
2	Wall board	A3			670	115	28	16
3	Wall board	B2			2950	115	28	16
4	Wall board	C1, D1			2000	115	28	30
5	Wall board	C2, D2			2200	115	28	2
6	Wall board	C3, D3			2500	115	28	2
7	Wall board							
8	Wall board	A1, B1			2950	60	28	2
9	Apex	A4			2950		28	1
10	Apex	B3			2950		28	1
11	Door	D-3			1880	1590		1
12	Roof board				1650	135	19	38
13	Fascia board				1700	120	16	4
14	Roof cover fixture				1700	50/38	16	4
15	Roof cover fixture				2500	50/38	16	2
16	Diamond							2
17	Beam				2500	120	40	3
18								
19								
20								
21								

PACKAGE NR.:	MNFCT. ORDER NR.:	PAGE/PAGES: <b>1/6</b>
<b>CONTROL 1</b> SIGNATURE	<b>CONTROL 2</b> SIGNATURE	

BUILDING CODE

# Anja

WALL LOG (mm): 28

SIZE (mm): 2950x2000

## ISOMETRIC VIEW

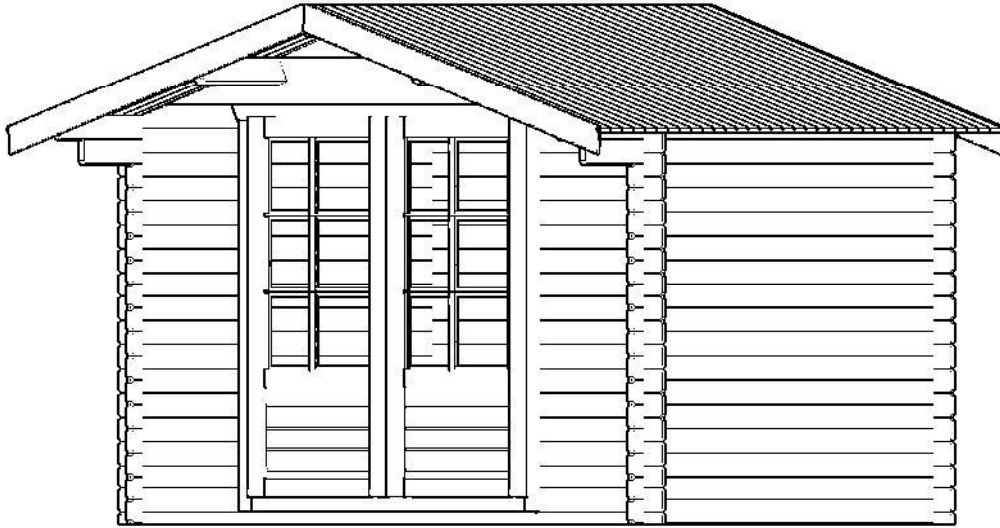

## TOP VIEW

A-FRONT  
B-BACK  
C-LEFT  
D-RIGHT

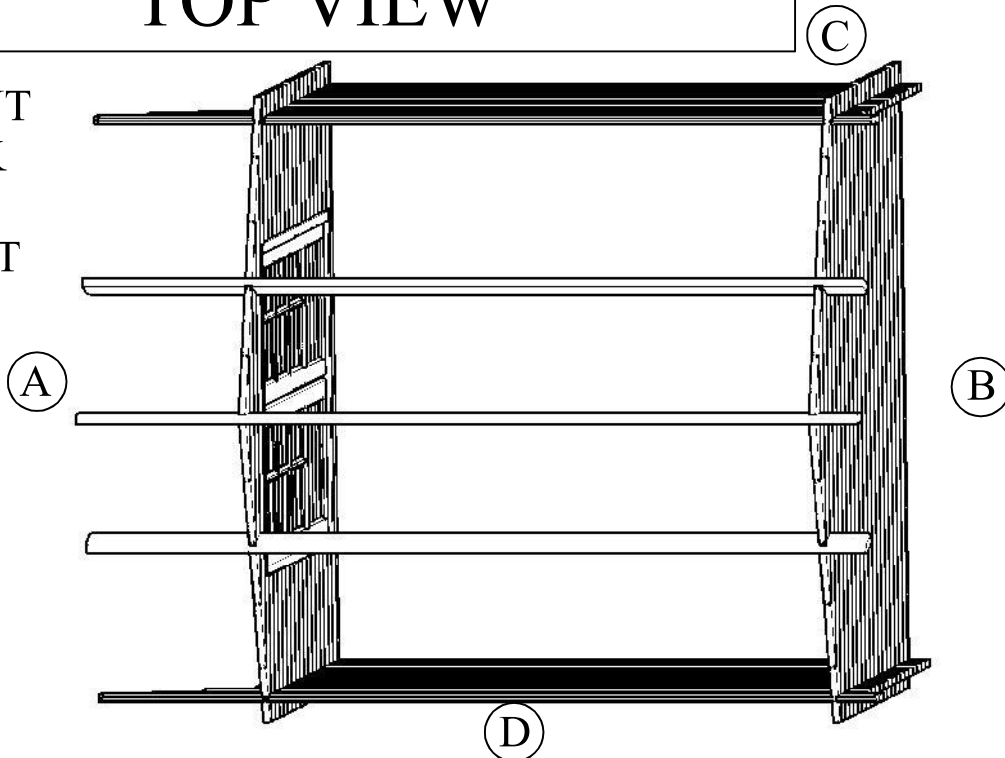

PACKAGE NR.:

MNFCT. ORDER NR.:

CONTROL 1

CONTROL 2

SIGNATURE

SIGNATURE

PAGE/PAGES: **2/6**

BUILDING CODE **Anja**

WALL LOG (mm): 28

SIZE (mm): 2950x2000

## FRONT VIEW

(A)

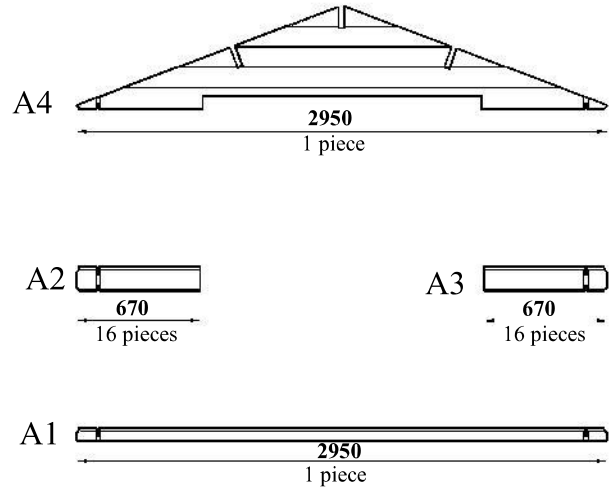
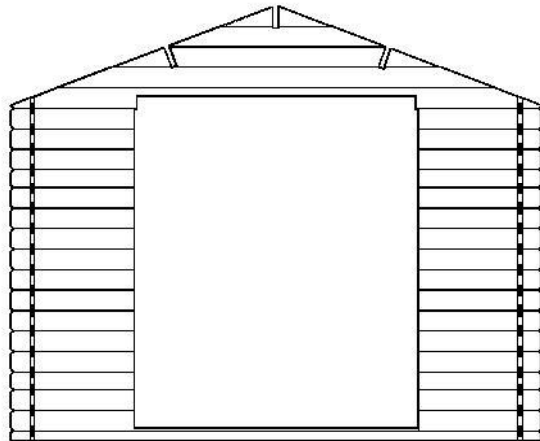

## BACK VIEW

(B)

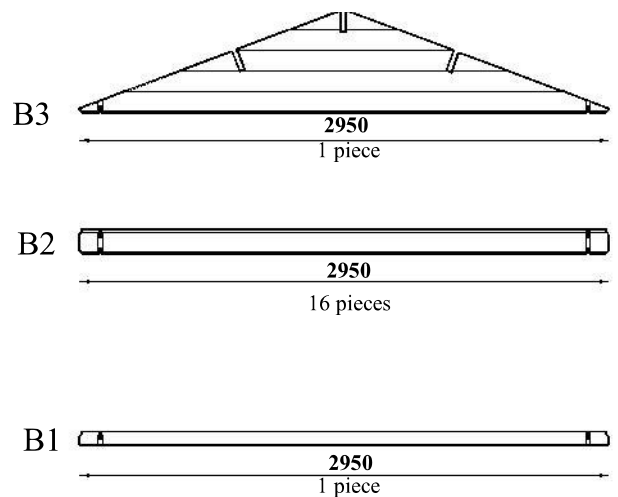
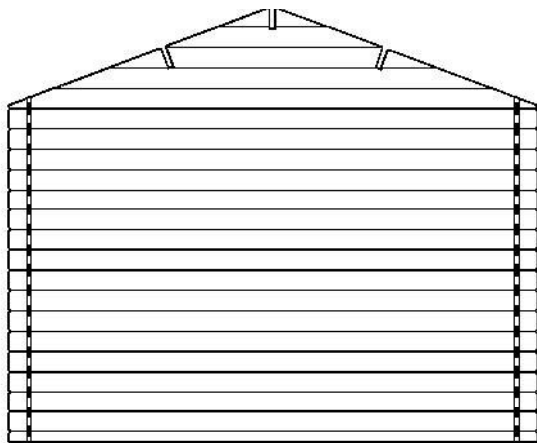

PACKAGE NR.:

MNFCT. ORDER NR.:

CONTROL 1

CONTROL 2

PAGE/PAGES: **3/6**

SIGNATURE

SIGNATURE

BUILDING CODE

# Anja

WALL LOG (mm): 28

SIZE (mm): 2950x2000

## LEFT VIEW

Ⓒ

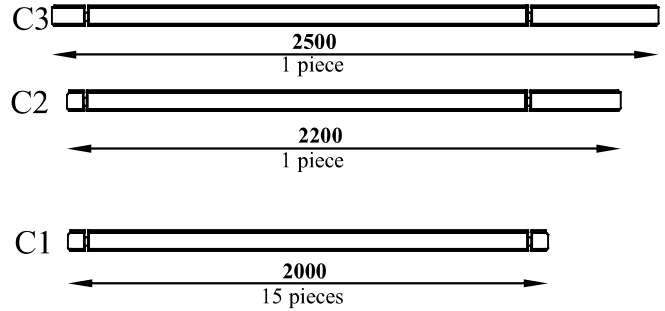
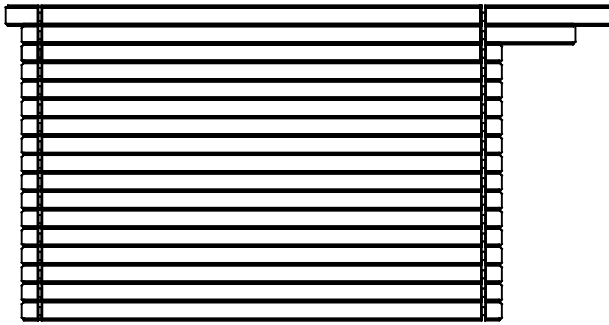

## RIGHT VIEW

Ⓓ

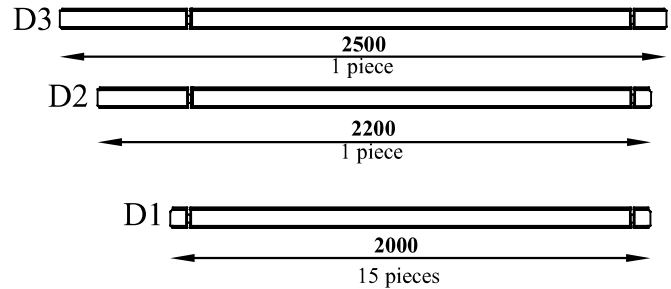
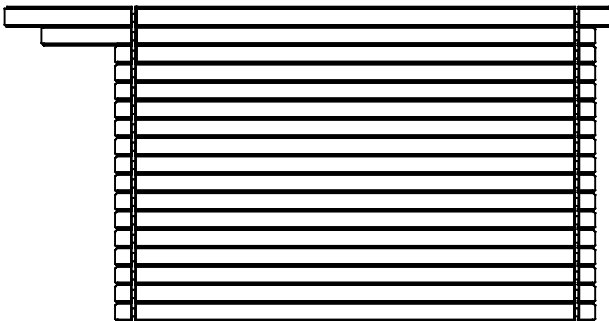

PACKAGE NR.:

MNFACT. ORDER NR.:

CONTROL 1

CONTROL 2

SIGNATURE

SIGNATURE

PAGE/PAGES: **4/6**

BUILDING CODE **Anja**

WALL LOG (mm): 28

SIZE (mm): 2950x2000

## CONSTRUCTION 1

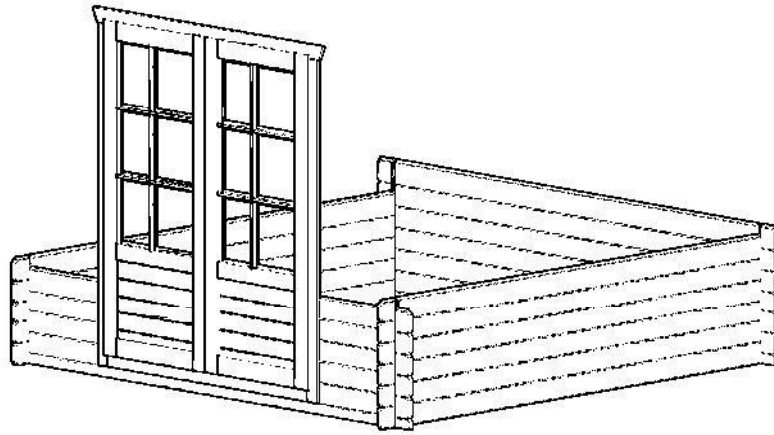

## CONSTRUCTION 2

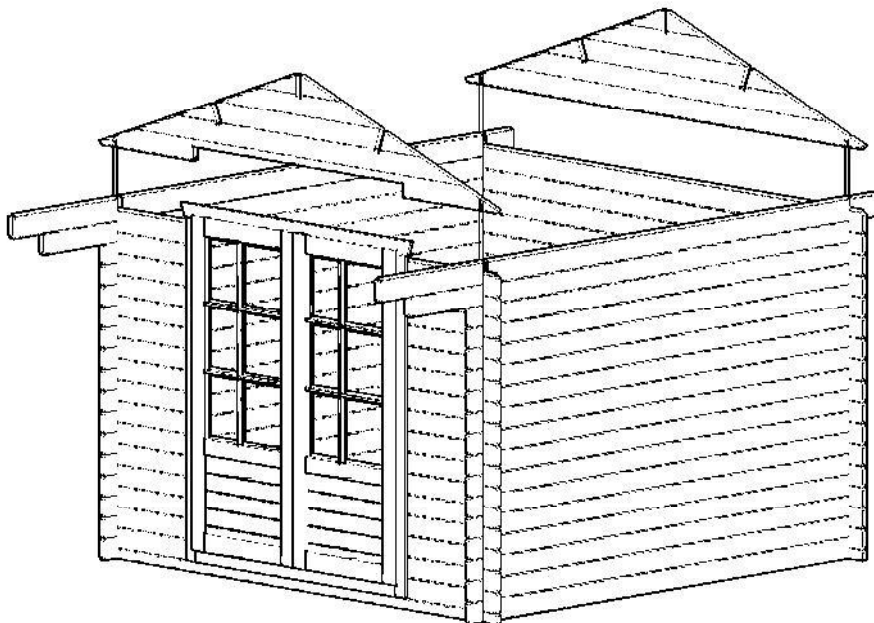

PACKAGE NR.:

MNFCT. ORDER NR.:

**CONTROL 1**

**CONTROL 2**

PAGE/PAGES:

**5/6**

SIGNATURE

SIGNATURE

BUILDING CODE **Anja**

WALL LOG (mm): 28

SIZE (mm): 2950x2000

## CONSTRUCCION 3

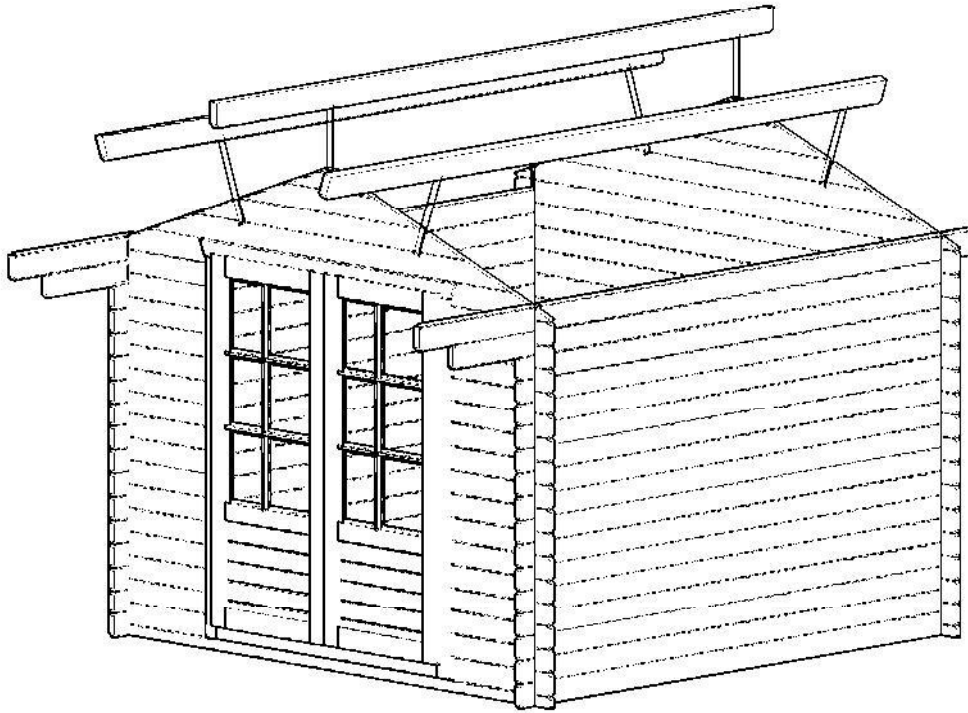

## CONSTRUCCION 4

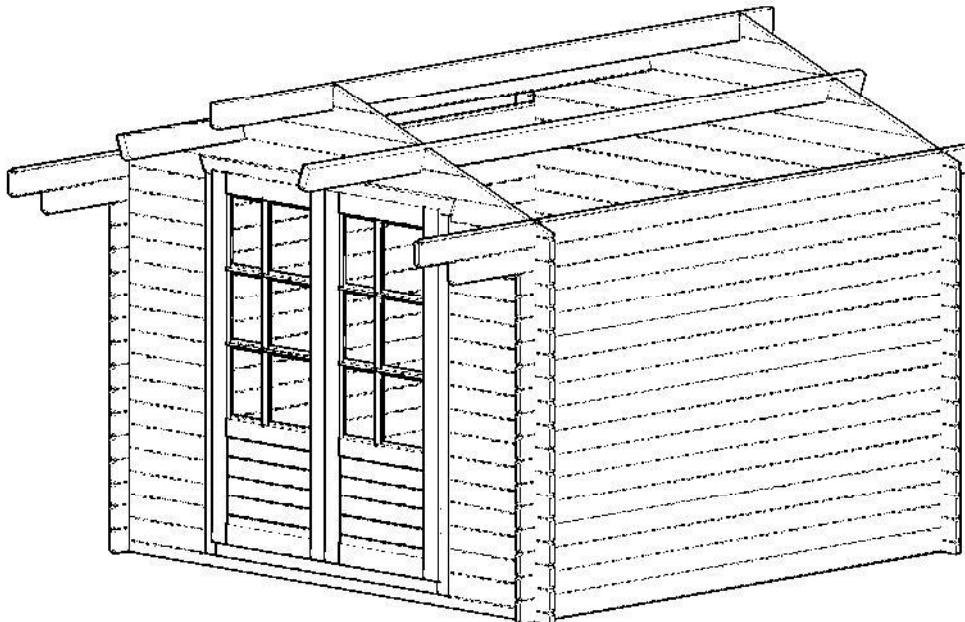

PACKAGE NR.:

MNFCT. ORDER NR.:

**CONTROL 1**

**CONTROL 2**

PAGE/PAGES: **6/6**

SIGNATURE

SIGNATURE