

BUILDING CODE **Ultramodern**

WALL LOG (mm): 28

SIZE (mm): 3200x2600

COMPONENT SPECIFICATION

NUMBER	COMPONENT FUNCTION	COMPONENT CODE	VIEW	SIDE VIEW	DIMENSIONS (mm)			QUANTITY (psc.)
					LENGHT	WIDTH	THICKNESS	
1	Wall board	A5,A7			405	115	28	21
2	Wall board	A9,B2			3200	115	28	19
3	Wall board	A6			405	115	28	5
4	Wall board	A8			3200	115	28	1
5	Wall board	A10			3400	115	28	1
6	Wall board	C1,D1			2600	115	28	36
7	Wall board	A3			1945	115	28	10
8	Wall board	A4			1945	115	28	1
9	Wall board	B3			3400	115	28	1
10	Wall board	C2,D2			2800	115	28	2
11	Wall board	A1,A2			405/1945	55	28	1/1
12	Wall board	B1			3200	55	28	1
13	Beam				3400	120	40	2
14	Roof board				2731	140	19	25
15	Window				1120	570		1
16	Door D-1				1880	830		1
17	Fascia board				3400	38/50	16	2
18	Fascia board				2800	38/50	16	2
19	Apex	C3,D3			2800	115	28	2
20	Roof	A11,B4			3438	260	19	2
21	Roof	C4,D4			2800	260	19	2
22								
23								
24								
25								

PACKAGE NR.:

MNFCT. ORDER NR.:

CONTROL 1
SIGNATURE

CONTROL 2
SIGNATURE

PAGE/PAGES: **1/5**

BUILDING CODE **Ultramodern**

WALL LOG (mm): 28

SIZE (mm): 3200x2600

ISOMETRIC VIEW

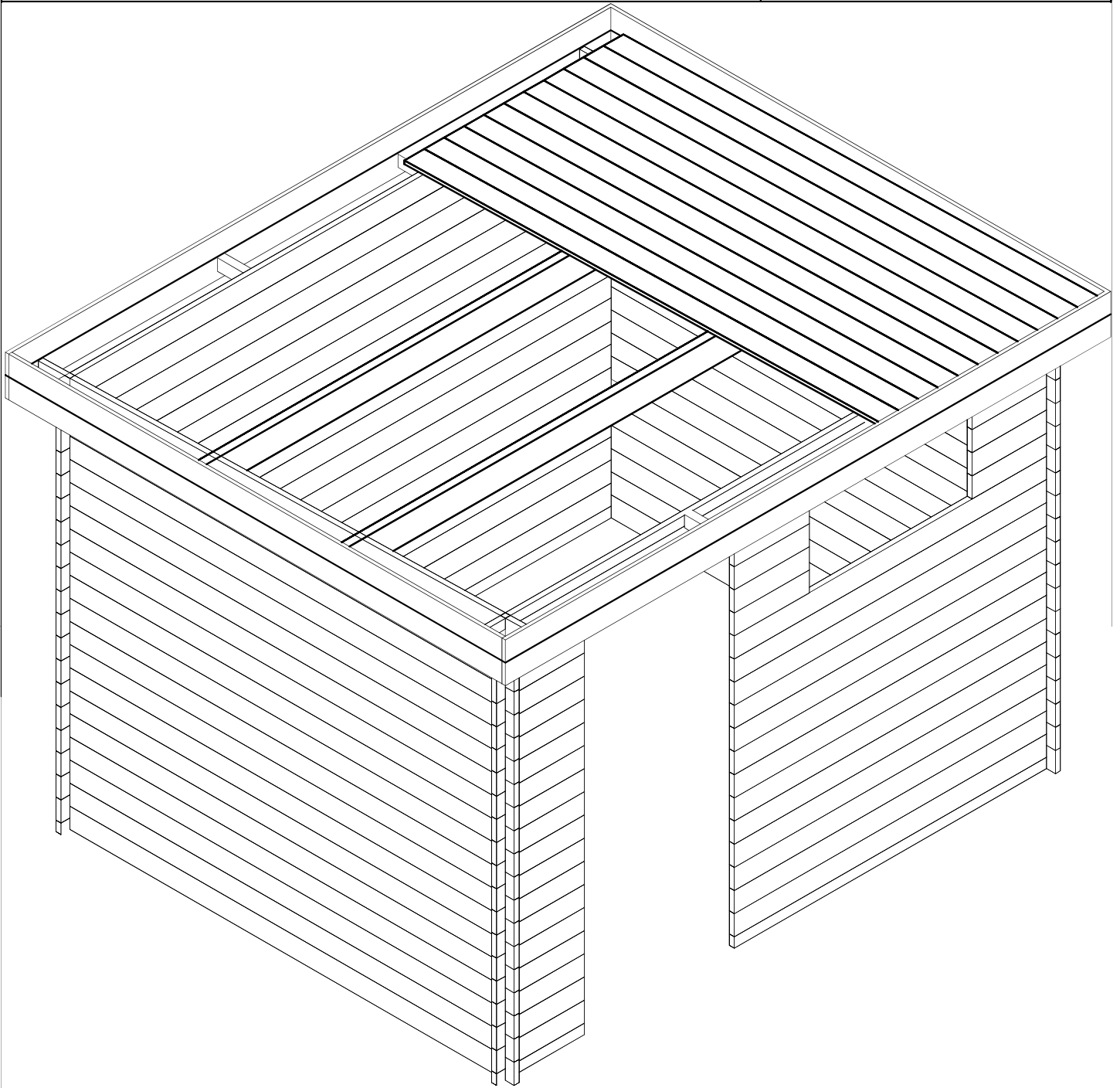

PACKAGE NR.:

MNFCT. ORDER NR.:

CONTROL 1

CONTROL 2

PAGE/PAGES: **2/5**

SIGNATURE

SIGNATURE

BUILDING CODE

Ultramodern

Wall log (mm):28

Size (mm):3200x2600

FRONT VIEW

-A-

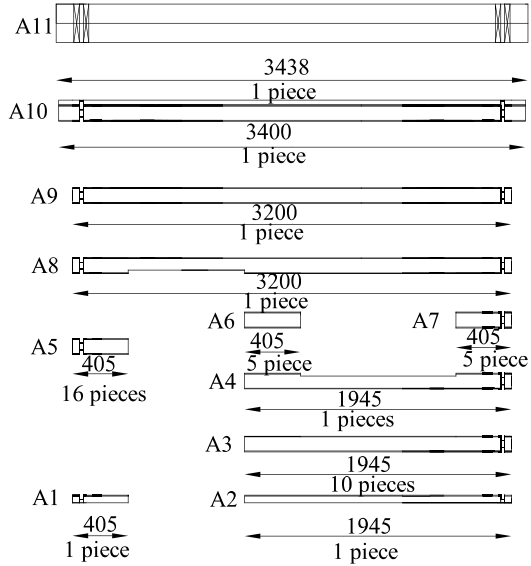
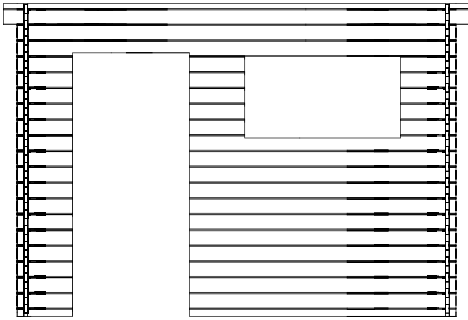

BACK VIEW

-B-

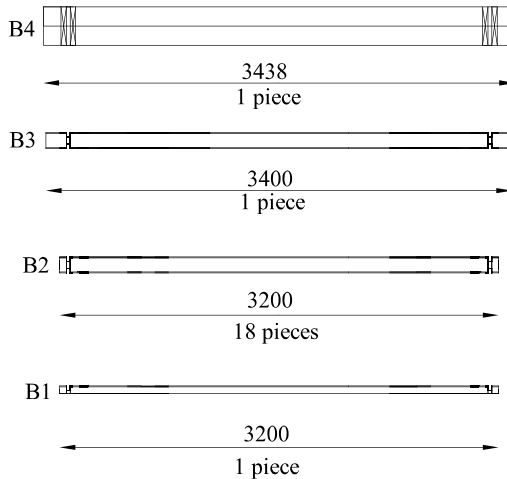
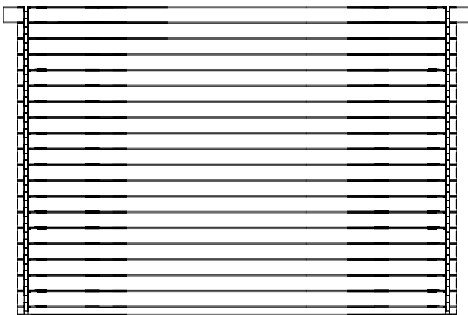

PACKAGE NR.:

MNFCT.ORDER NR

CONTROL 1

CONTROL 2

SIGNATURE

SIGNATURE

PAGE/PAGES: **3/5**

BUILDING CODE

Ultramodern

Wall log (mm):28

Size (mm):3200x2600

LEFT VIEW

-C-

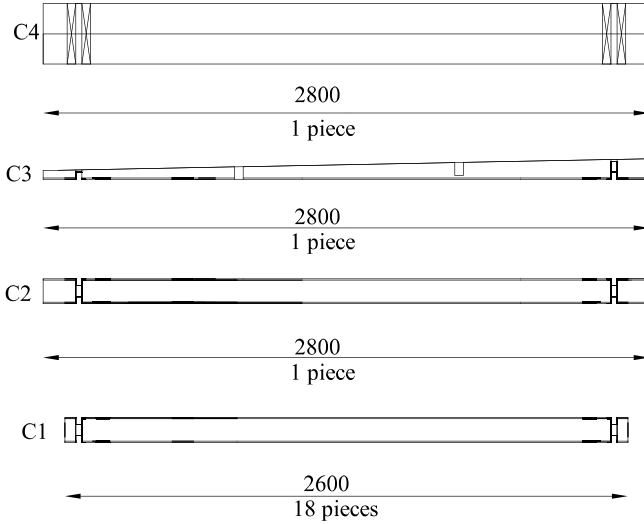
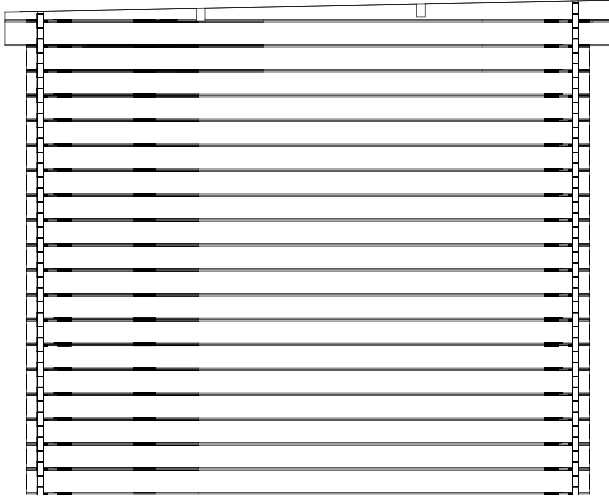

RIGHT VIEW

-D-

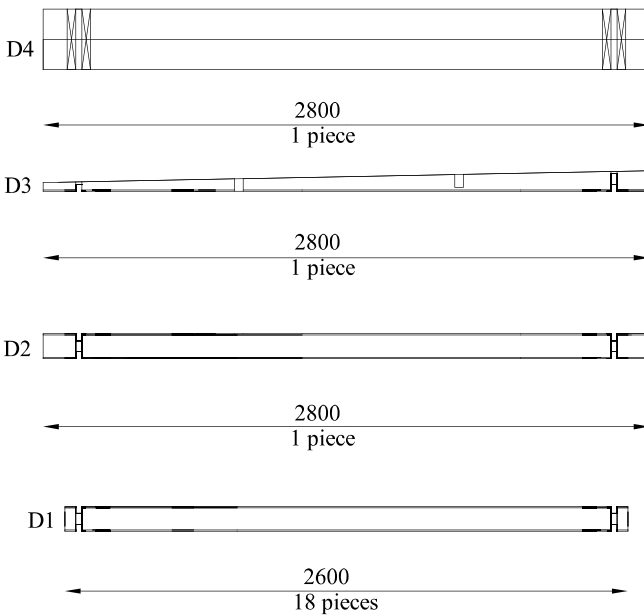
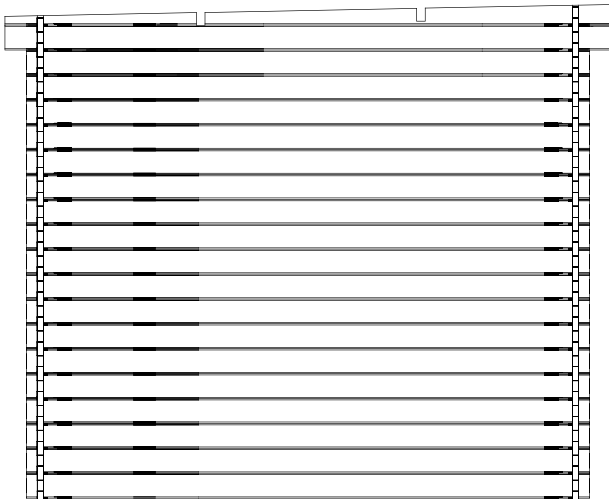

PACKAGE NR.:

MNFCT.ORDER NR

CONTROL 1

CONTROL 2

SIGNATURE

SIGNATURE

PAGE/PAGES: **4/5**

BUILDING CODE

Ultramodern

Wall log (mm):28

Size (mm):3200x2600

PLAN

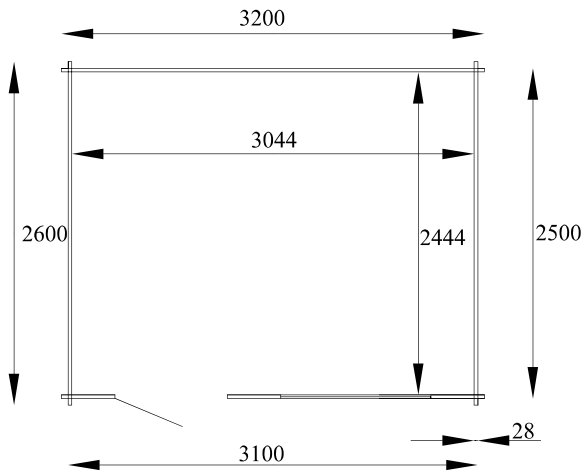

ROOF PLAN

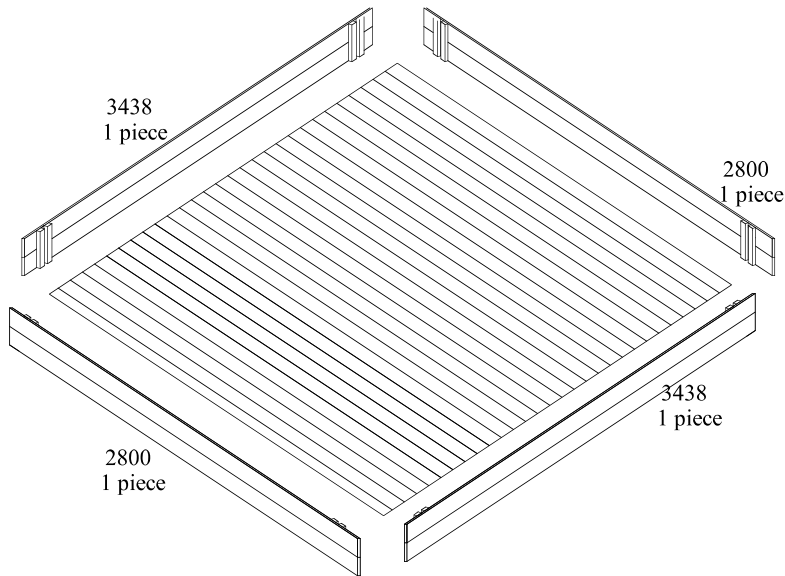

PACKAGE NR.:

MNFCT.ORDER NR

CONTROL 1

CONTROL 2

SIGNATURE

SIGNATURE

PAGE/PAGES: **5/5**