

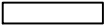

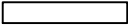

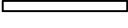

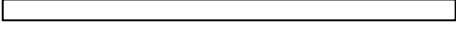

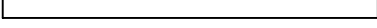

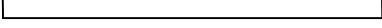
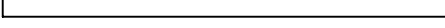



Perla28

Pos	Specification-Spezifikation-Specificatie	St.	Profile (mm)	Length (mm)	
001		32	28x135	645	
002		30	28x135	800	
003		4	28x68	800	
004		16	28x135	2913	
005		30	28x135	2413	
KB1	DIAGONAL 	6	44x144	450	
KB2	DIAGONAL 	2	44x144	200	
SR1	RAFTER-DACHSPARREN-DAKSPAR 	2	44x144	2442	
PR1	Purlin-Dakbalk-Dachpfette 	5	44x144	2852	
DP-1	Roof board-Dachbrett-Dakplank 	34	88x18	2485	
L-1	Eave Slat-Traufenleiste-Afdekljst 	4	40x18	12 rmt.	
L-2	Facia Board-Giebelblende-Gevelplank 	4	18x120	3000	
L-3	Slat-Lleiste-Lijst 	4	40x18	12 rmt.	
	Door Knob Set-Türknauf Satz-Deurknop Set 	1			
	Screw-Schraube-Schroef 4x60 	200			
	Screw-Schraube-Schroef 6x120 	50			
P1	Post 	2	85x85	2225	
P2	Post 	1	85x85	2225	
P3	Post 	2	85x85	2225	
P4	Post 	1	85x85	2225	
P5	Post 	2	44x70	2225	
W0	WINDOW 2913x270 	1			
Kood		Materjal		File Perla28.dwg	Leht 1/1

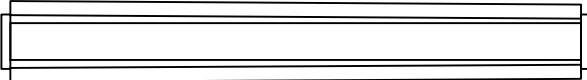
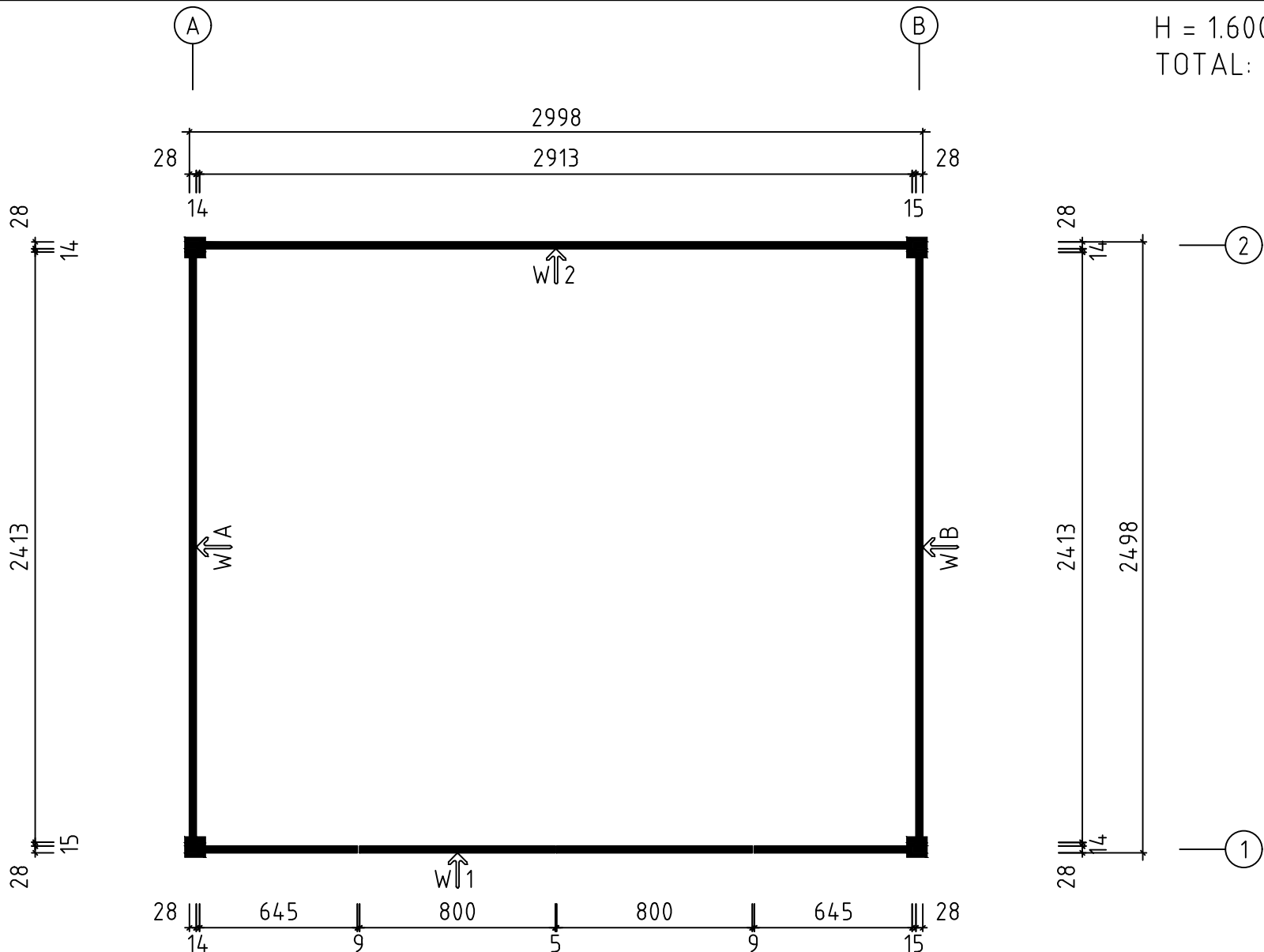

H = 1.600 m
TOTAL: 0.00 m²

Model	Perla28	Page	PLAN
Client		Scale	1:30
Material	28x135mm	Date	13.12.2019
Company		File	Perla28.dwg

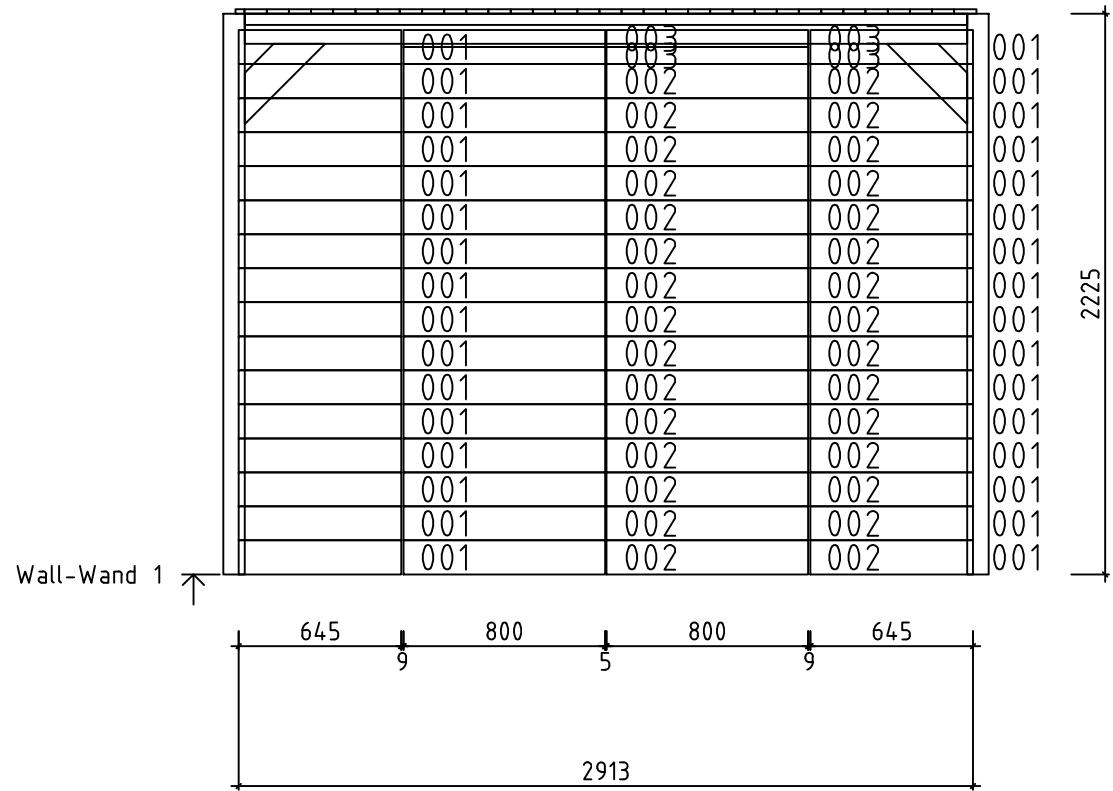

Model	Perla28	Page	4
Client		Scale	1:30
Material	2.8x13.5	Date	13.12.2019
Company		File	Perla28.dwg

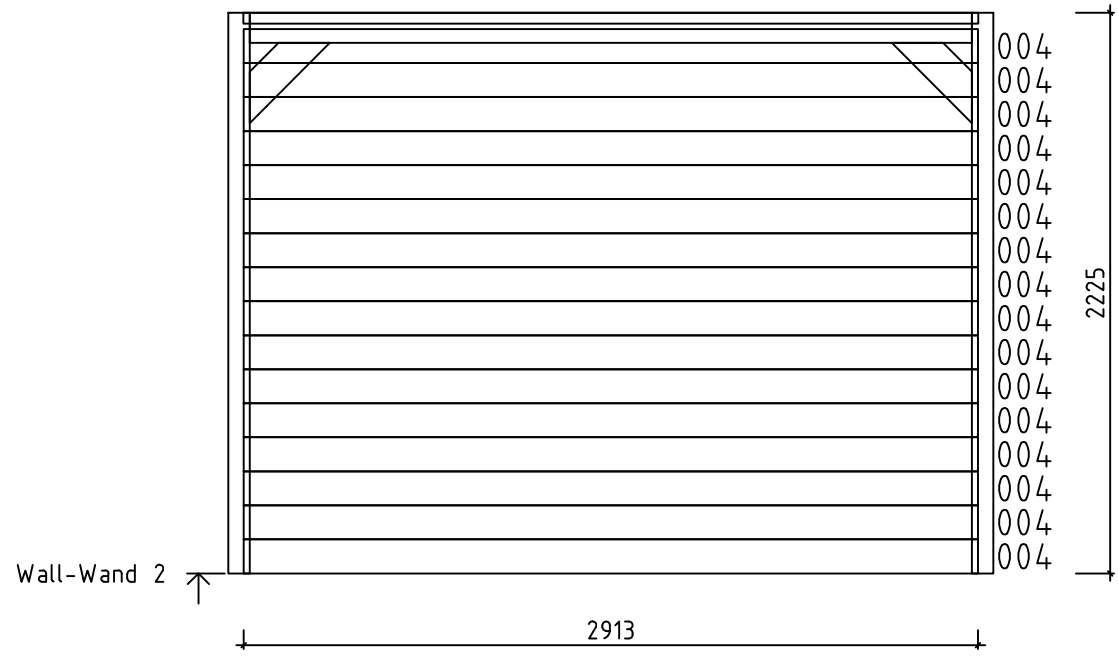

Model	Perla28	Page	5
Client		Scale	1:30
Material	2.8x13.5	Date	13.12.2019
Company		File	Perla28.dwg

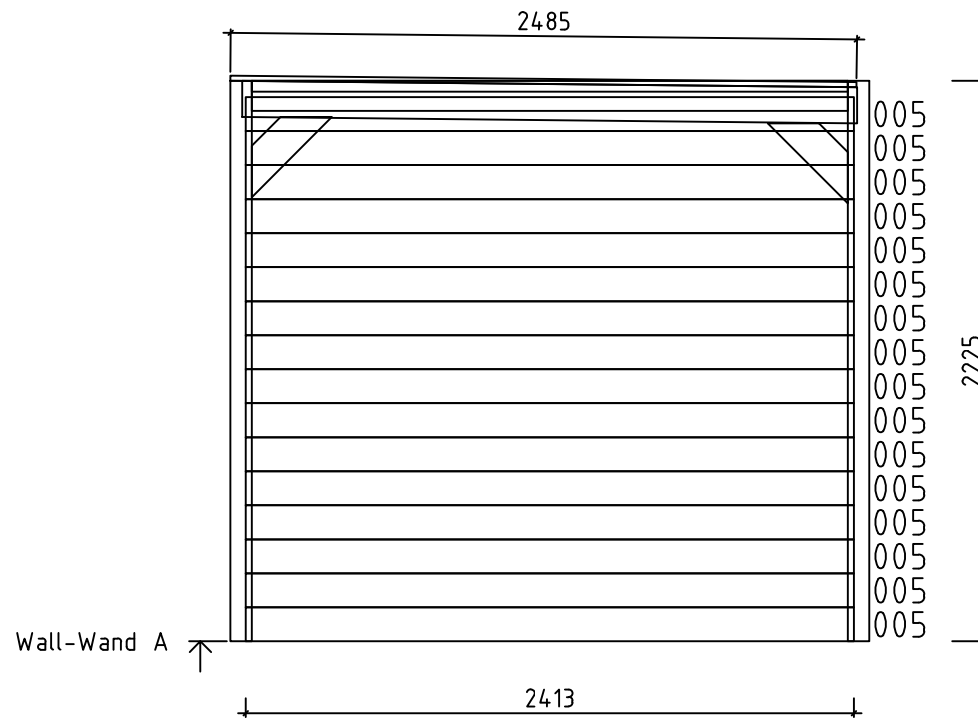

Model	Perla28	Page	2
Client		Scale	1:30
Material	2.8x13.5	Date	13.12.2019
Company		File	Perla28.dwg

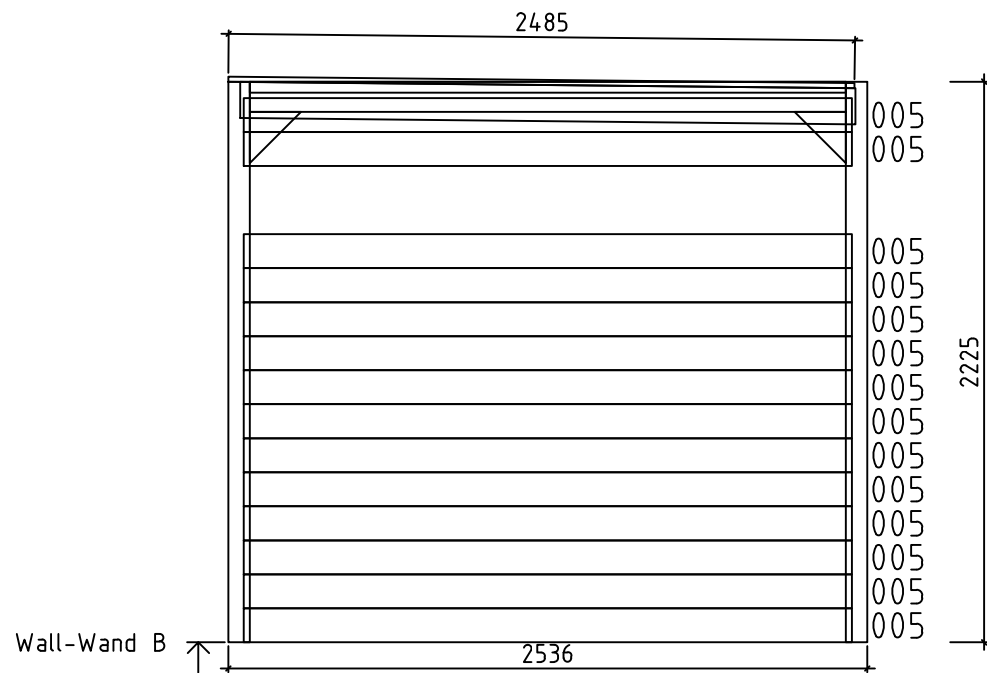

Model	Perla28	Page	3
Client		Scale	1:30
Material	2.8x13.5	Date	13.12.2019
Company		File	Perla28.dwg

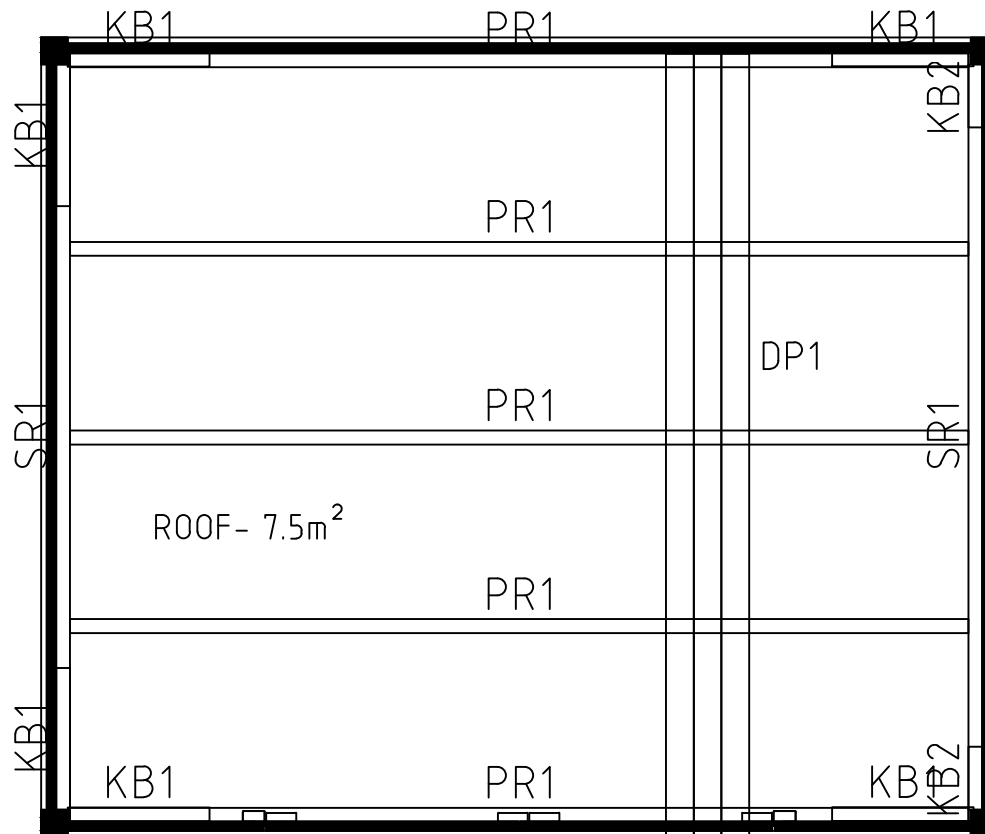

Model	Perla28	Page	ROOF
Client		Scale	1:30
Material	28x135mm	Date	13.12.2019
Company		File	Perla28.dwg