

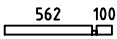

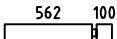

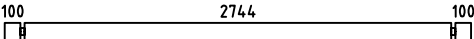

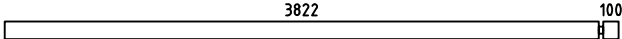

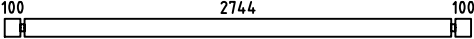
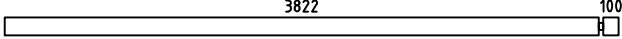
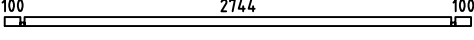
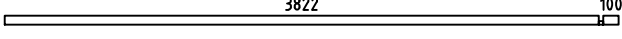

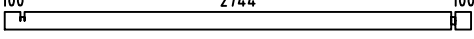
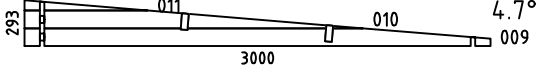
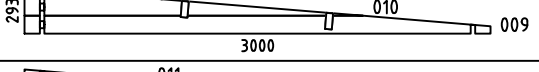
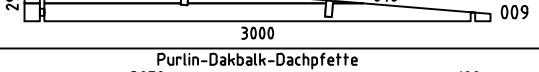
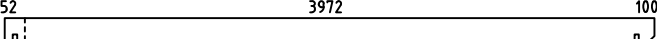
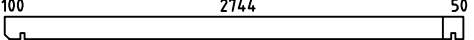

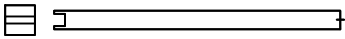
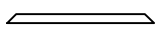
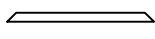
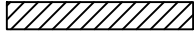
Charlotta28

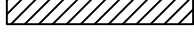
Pos	Specification-Spezifikation-Specificatie	St.	Profile (mm)	Length (mm)
001		2	28x57	690
002		33	28x114	690
003		48	28x114	3000
004		16	28x114	3950
005		2	28x114	3000
006		2	28x114	3950
007		1	28x57	3000
008		1	28x57	3950
012		15	28x114	315
013		1	28x114	3000
WA-1		1		
WB-1		1		
WC-1		1		
PR2		2	44x14.4	4180
PR1		2	44x14.4	2950
DP-1	Roof board-Dachbrett-Dakplank 	80	88x18	3250
	-POST 85x85 	1		2005
PS1	Diagonal for POST 44x85 	1		450
PS2	Diagonal for POST 44x85 	1		500
L-1	Eave Board-Traufenblende-Afdeklank 	2	18x120	3290
L-2	Eave Slat-Traufenleiste-Afdekljst 	2	40x18	3290
L-3	Eave Slat-Traufenleiste-Afdekljst 	4	40x18	3518
L-4	Facia Board-Giebelblende-Gevelplank 	4	18x120	3518
H1	H-Profile 	1		228
H2	H-Profile 	1		1835
Kood	Materjal	File	Charlotta28.dwg	Leht 1/2

Pos	Specification-Spezifikation-Specificatie	St.	Profile (mm)	Length (mm)
	Adjustable foot-Stellfuß+Schrauben 4x50 4stück für Post 	1		
	Double Door Set-Doppeltür Satz-Dubbele Deur Set 	1		
	Nail-Nagel-Spijker 1.2x20 	15	1.2x20	
DD6 1 60X185	<p>DOOR 1600x1850</p>  <p>Door Glazing Bar Türsprossen Deurroeden</p> 	1		
Kood	Materjal	File	Charlotta28.dwg	Leht 2/2

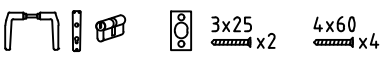
H = 1.500 m
TOTAL: 7.53 m²

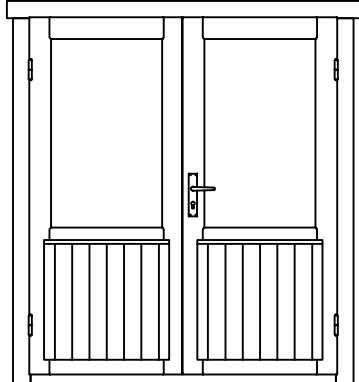
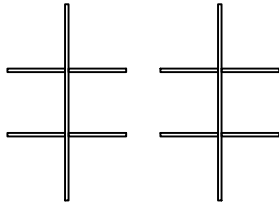
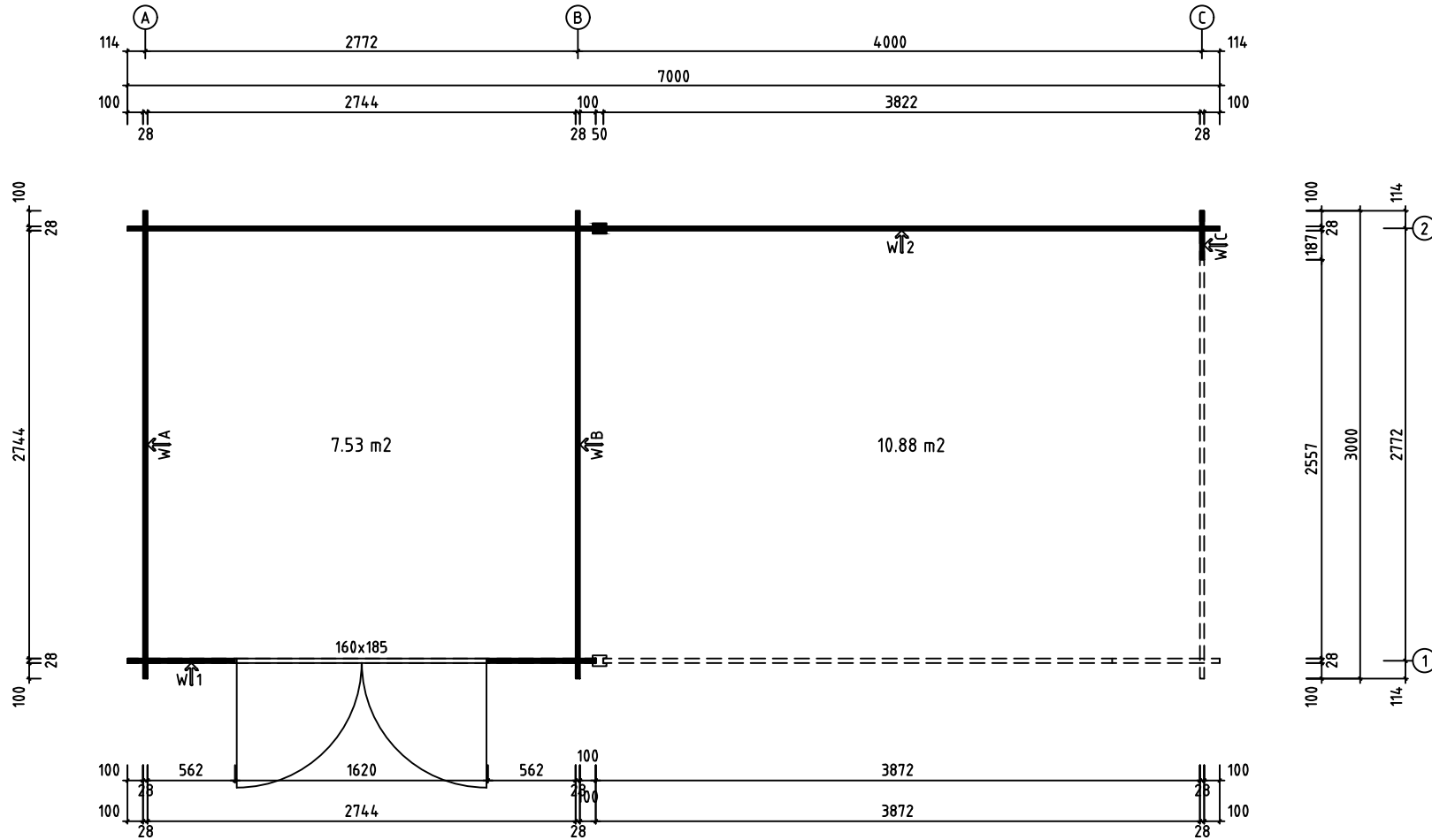

Model	Charlotta28	Page	
Client		Scale	1:30
Material	28x114mm	Date	09.04.2020
Company		File	Charlotta28.dwg

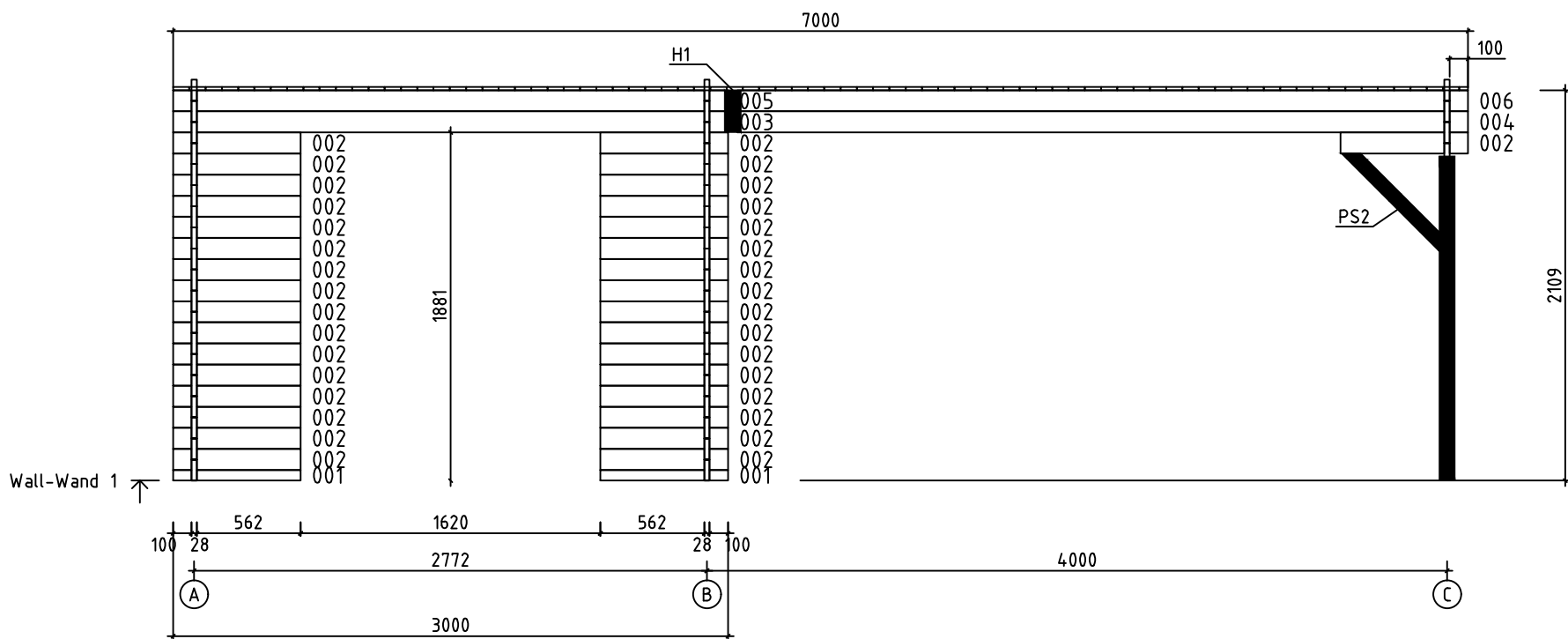

Model	Charlotta28	Page	5
Client		Scale	1:30
Material	2.8x11.4	Date	09.04.2020
Company		File	Charlotta28.dwg

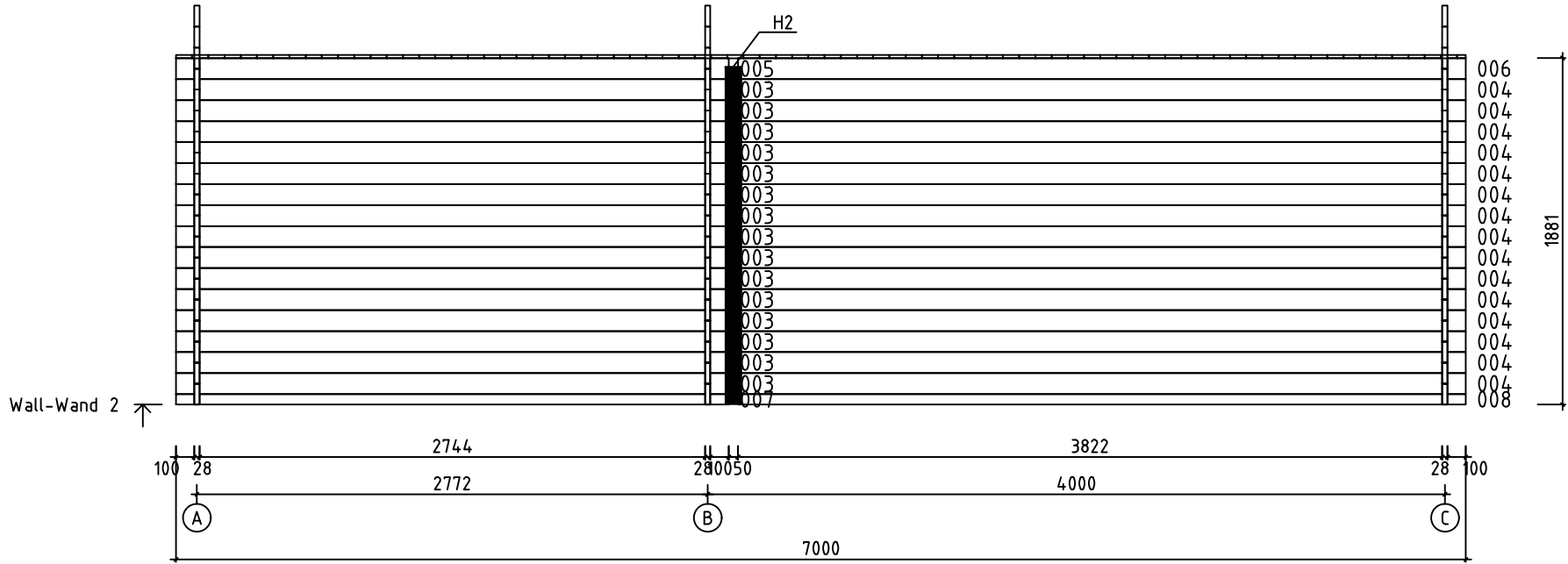

Model	Charlotta28	Page	6
Client		Scale	1:30
Material	2.8x11.4	Date	09.04.2020
Company		File	Charlotta28.dwg

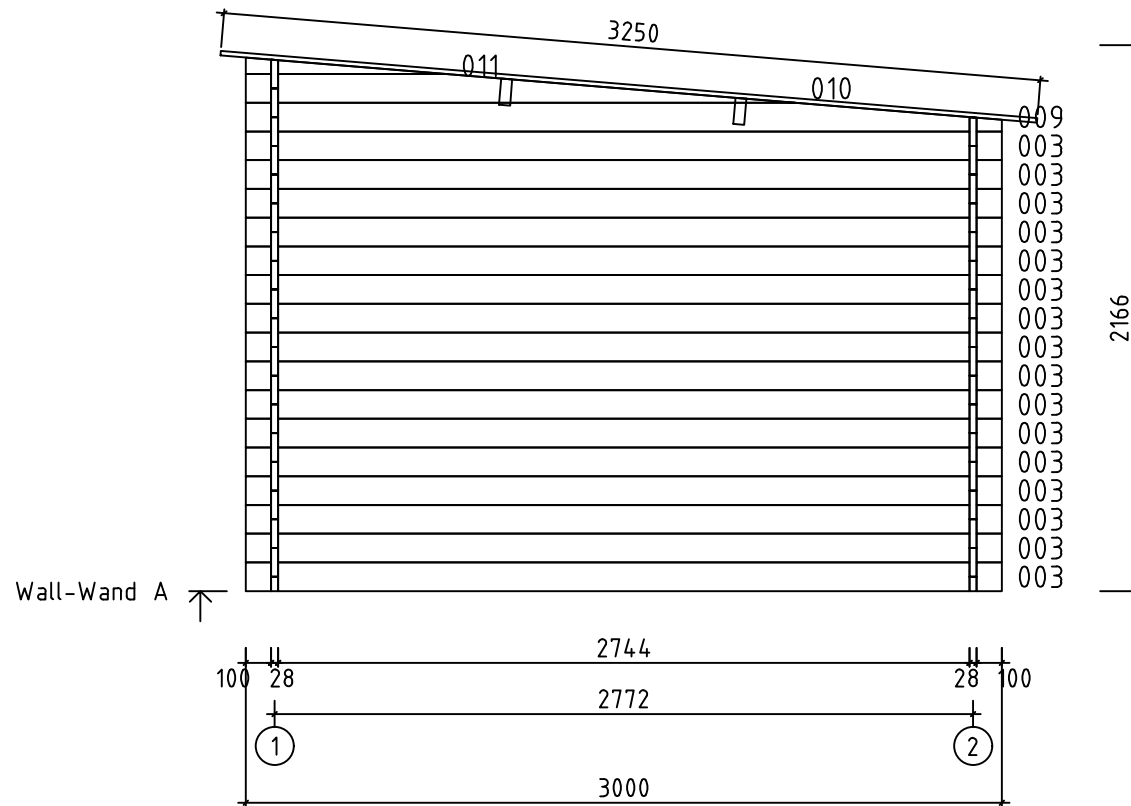

Model	Charlotta28	Page	2
Client		Scale	1:30
Material	2.8x11.4	Date	09.04.2020
Company		File	Charlotta28.dwg

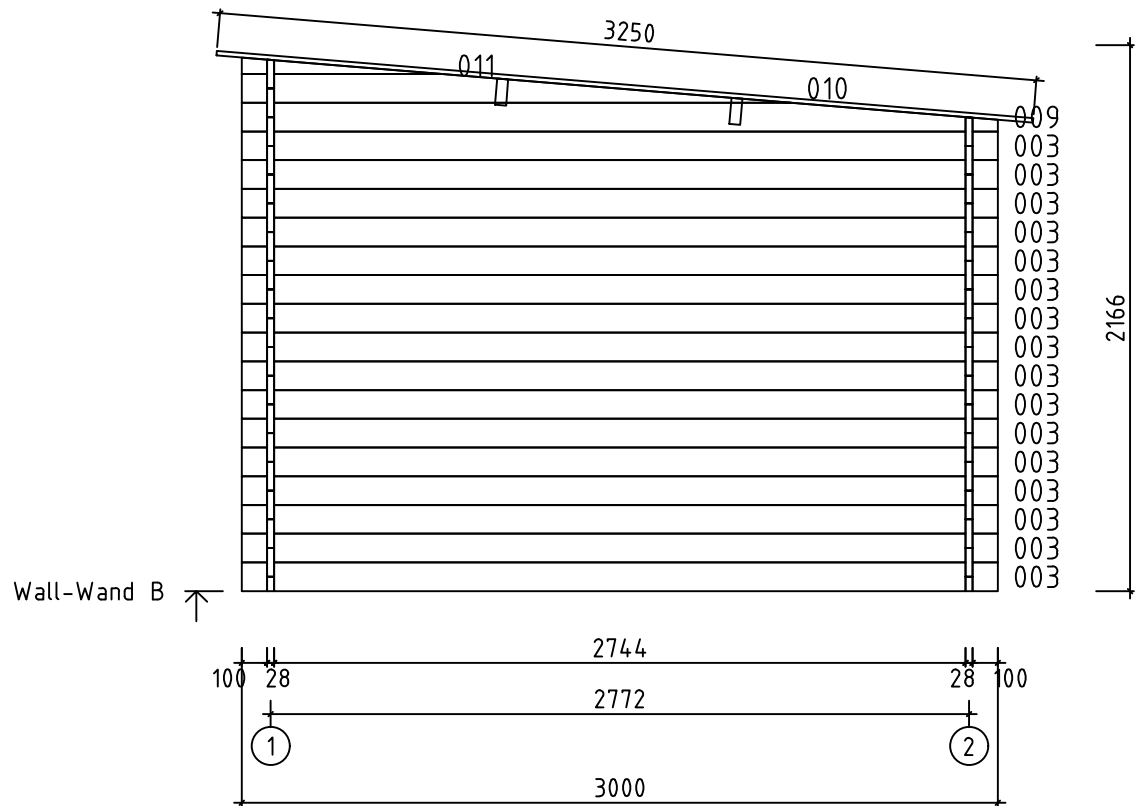

Model	Charlotta28	Page	3
Client		Scale	1:30
Material	2.8x11.4	Date	09.04.2020
Company		File	Charlotta28.dwg

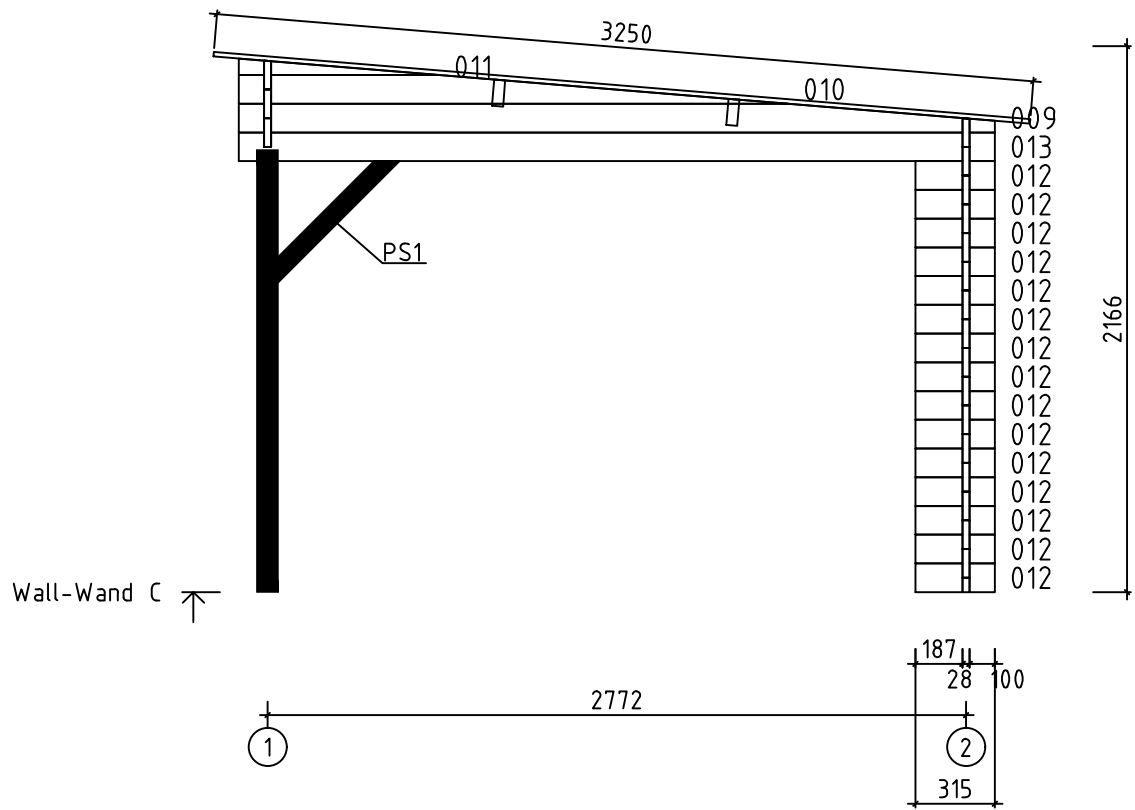

Model	Charlotta28	Page	4
Client		Scale	1:30
Material	2.8x11.4	Date	09.04.2020
Company		File	Charlotta28.dwg

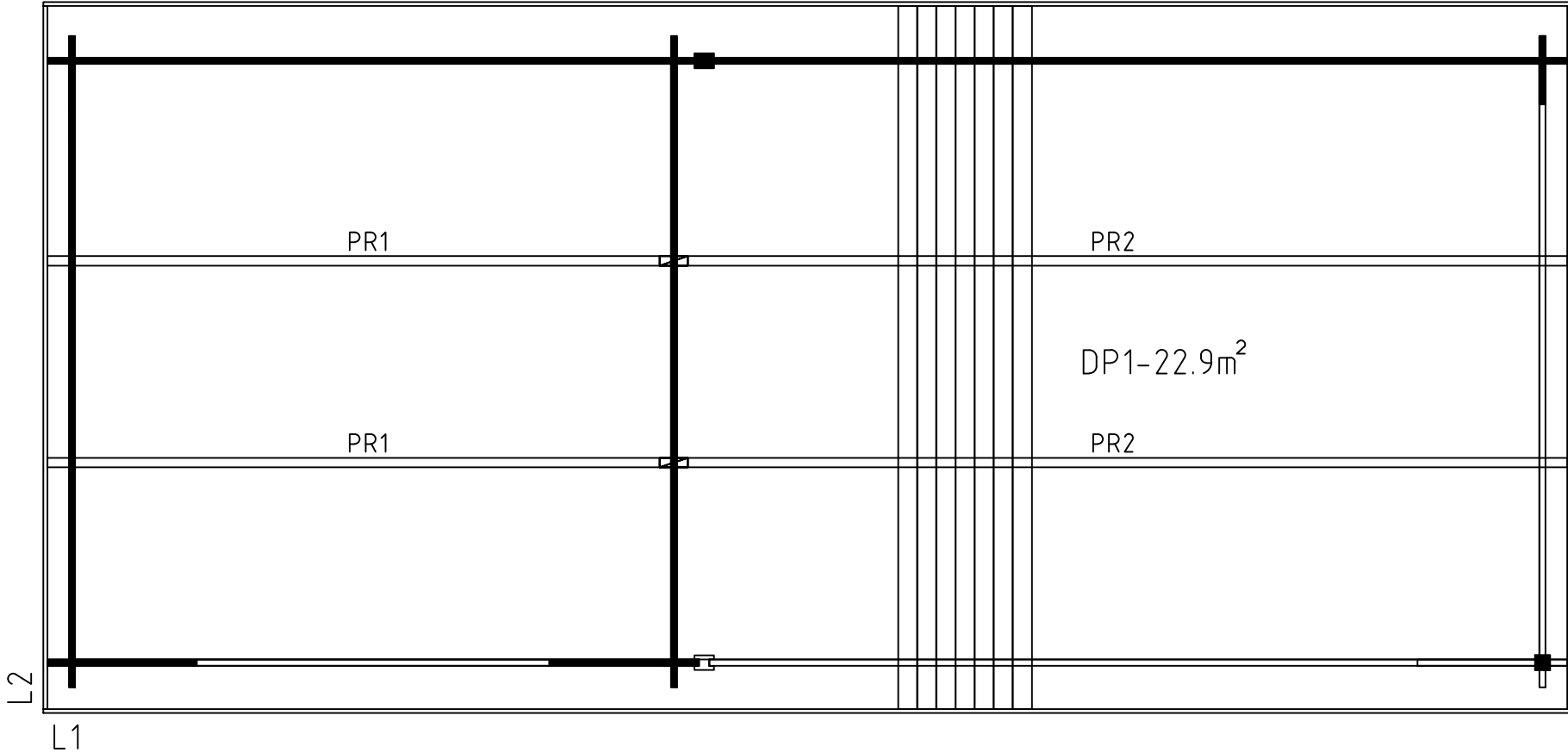
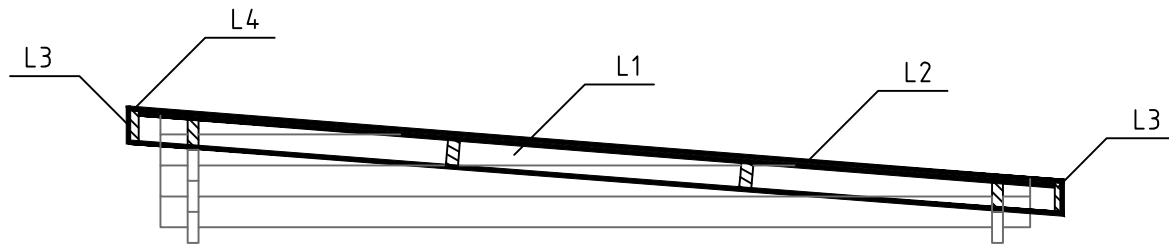

Model	Charlotta28	Page	
Client		Scale	1:30
Material	28x114mm	Date	09.04.2020
Company		File	Charlotta28.dwg

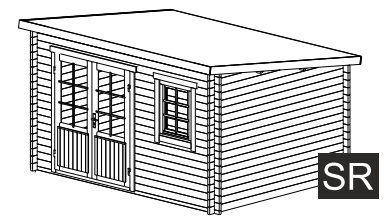
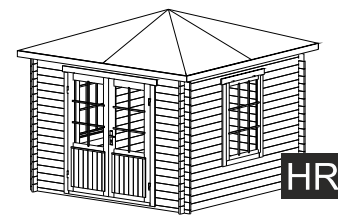
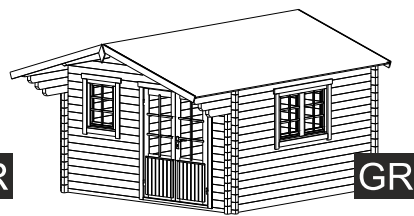
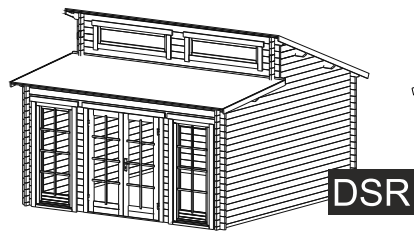
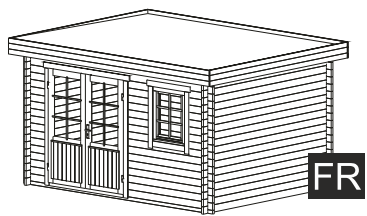

FR

DSR

GR

HR

SR

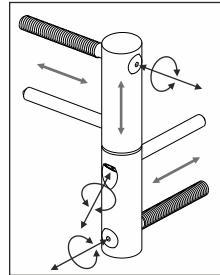
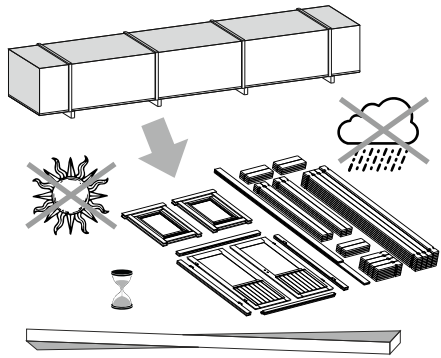

ADJUSTABLE HINGES

3.

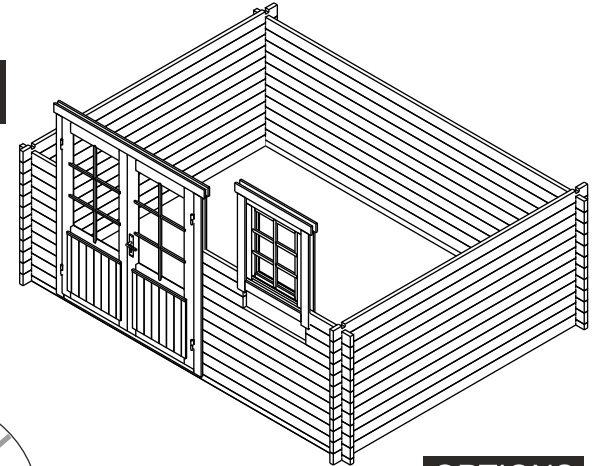

1.

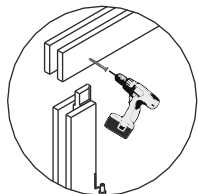
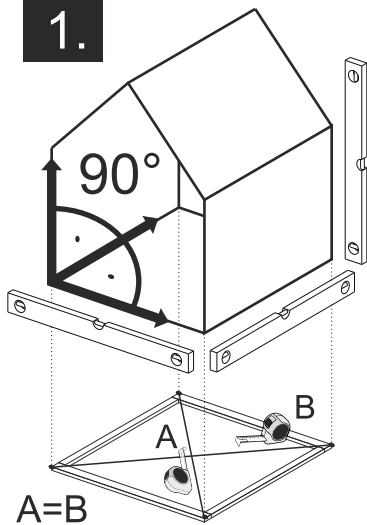

TYPE- B
4x60

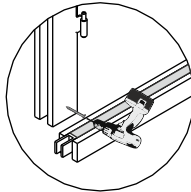

2.

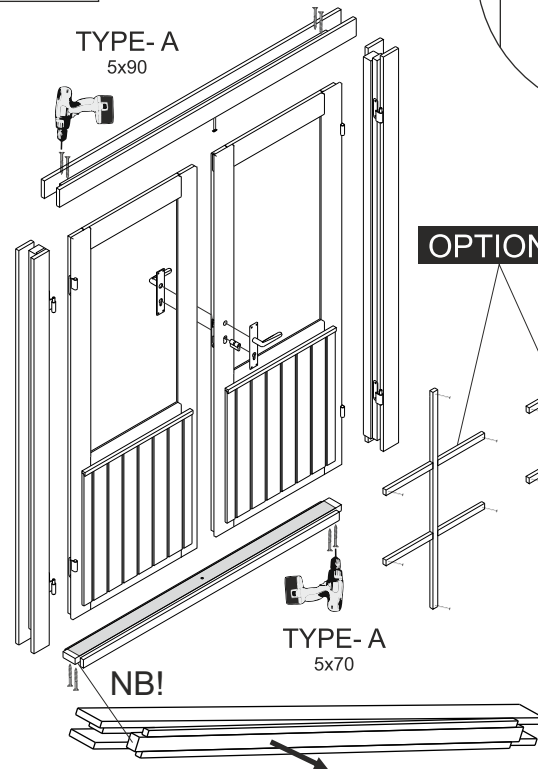

TYPE- A
5x90

TYPE- A
5x70

NB!

OPTIONS

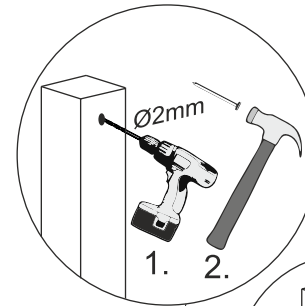

1. 2.

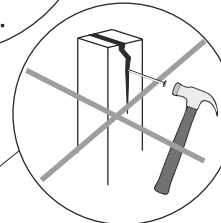

OPTIONS

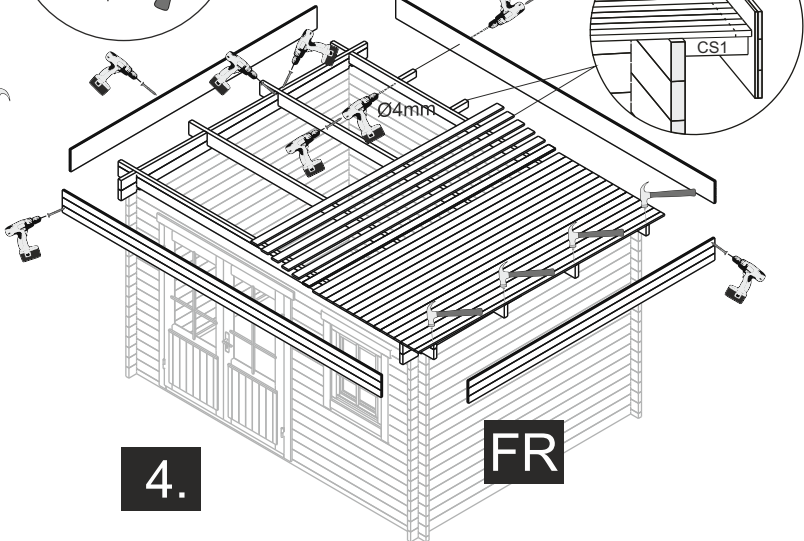
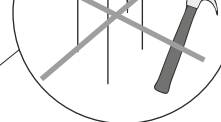

Ø4mm

Ø4mm

CS1

4.

FR

The guide is illustrative. This guide is not project specification.
Der Leitfaden ist illustrativ. Dieser Leitfaden ist keine Projektspezifikation.
De gids is illustratief. Deze gids is geen projectspecificatie.

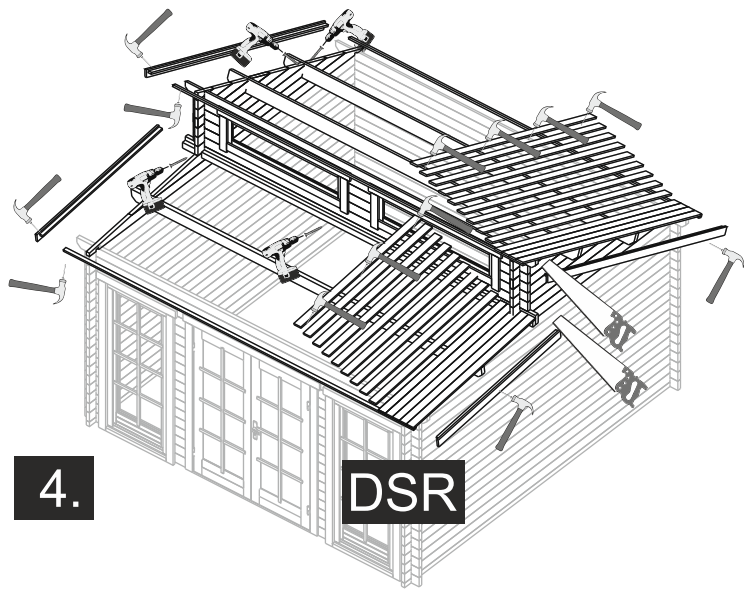

DSR

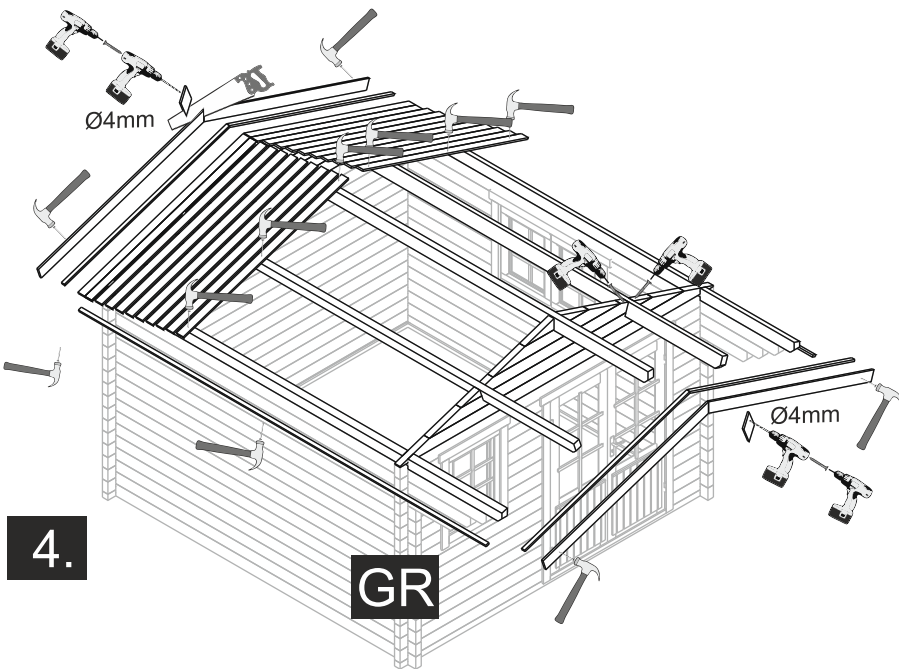

GR

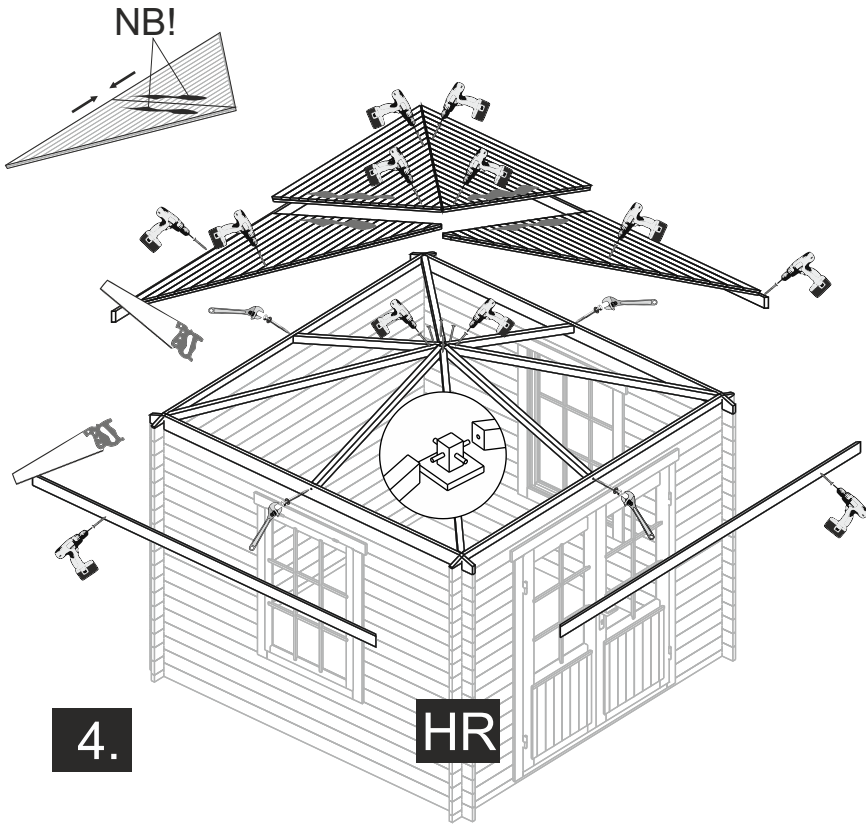

HR

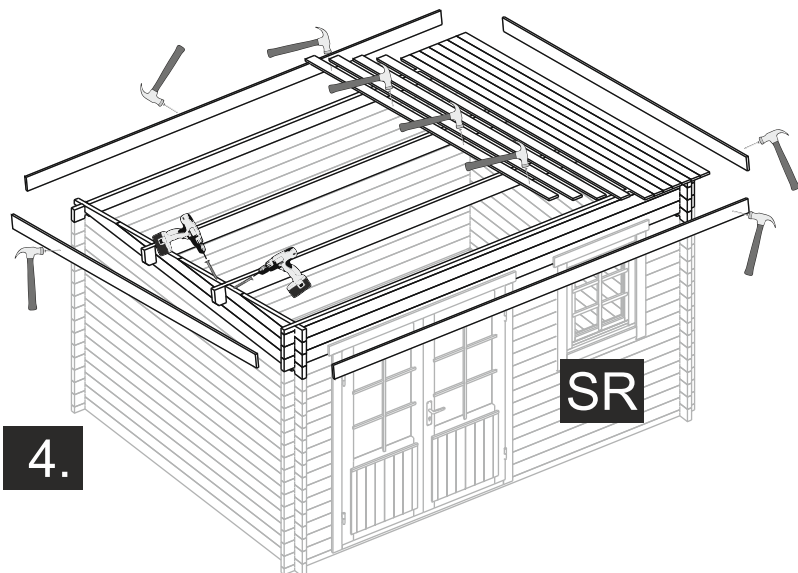

SR

OPTIONS

