

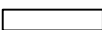

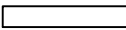

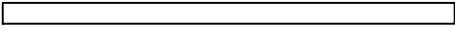

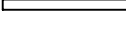

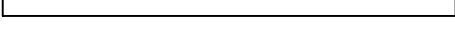

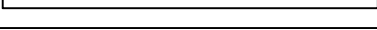

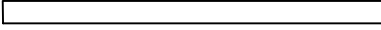
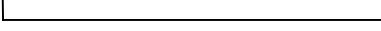
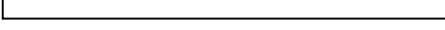





Rosanne28

Pos	Specification-Spezifikation-Specificatie	St.	Profile (mm)	Length (mm)
001		32	28x135	645
002		30	28x135	800
003		2	28x135	2907
004		4	28x68	800
005		32	28x135	2913
006		16	28x135	2875
007		31	28x135	2413
KB1	DIAGONAL 	6	44x144	450
KB2	DIAGONAL 	6	44x144	200
SR1	RAFTER-DACHSPARREN-DAKSPAR 	3	44x144	2442
SR2	RAFTER-DACHSPARREN-DAKSPAR 	1	44x144	2442
PR1	Purlin-Dakbalk-Dachpfette 	10	44x144	2852
DP-1	Roof board-Dachbrett-Dakplank 	66	88x18	2485
L-1	Cover board 	1	18x85	2105
L-2	Eave Slat-Traufenleiste-Afdekljst 	5	40x18	15 rmt
L-3	Facia Board-Giebelblende-Gevelplank 	6	18x120	3000
L-4	Slat-Lleiste-Lijst 	7	45x28	21 rmt
	Door Knob Set-Türknauf Satz-Deurknop Set 	1	3x25 x4	
	Joist hanger-Balkenaufhänger-Raveeldrager 	12		
	Screw-Schraube-Schroef 4x35 	120		
	Screw-Schraube-Schroef 4x60 	200		
	Screw-Schraube-Schroef 6x120 	50		
P1	Post 	2	85x85	2225
P2	Post 	1	85x85	2225
P3	Post 	2	85x85	2225
Kood	Materjal	File	Rosanne28.dwg	Leht 1/2



H = 1.600 m  
TOTAL: 0.00 m2

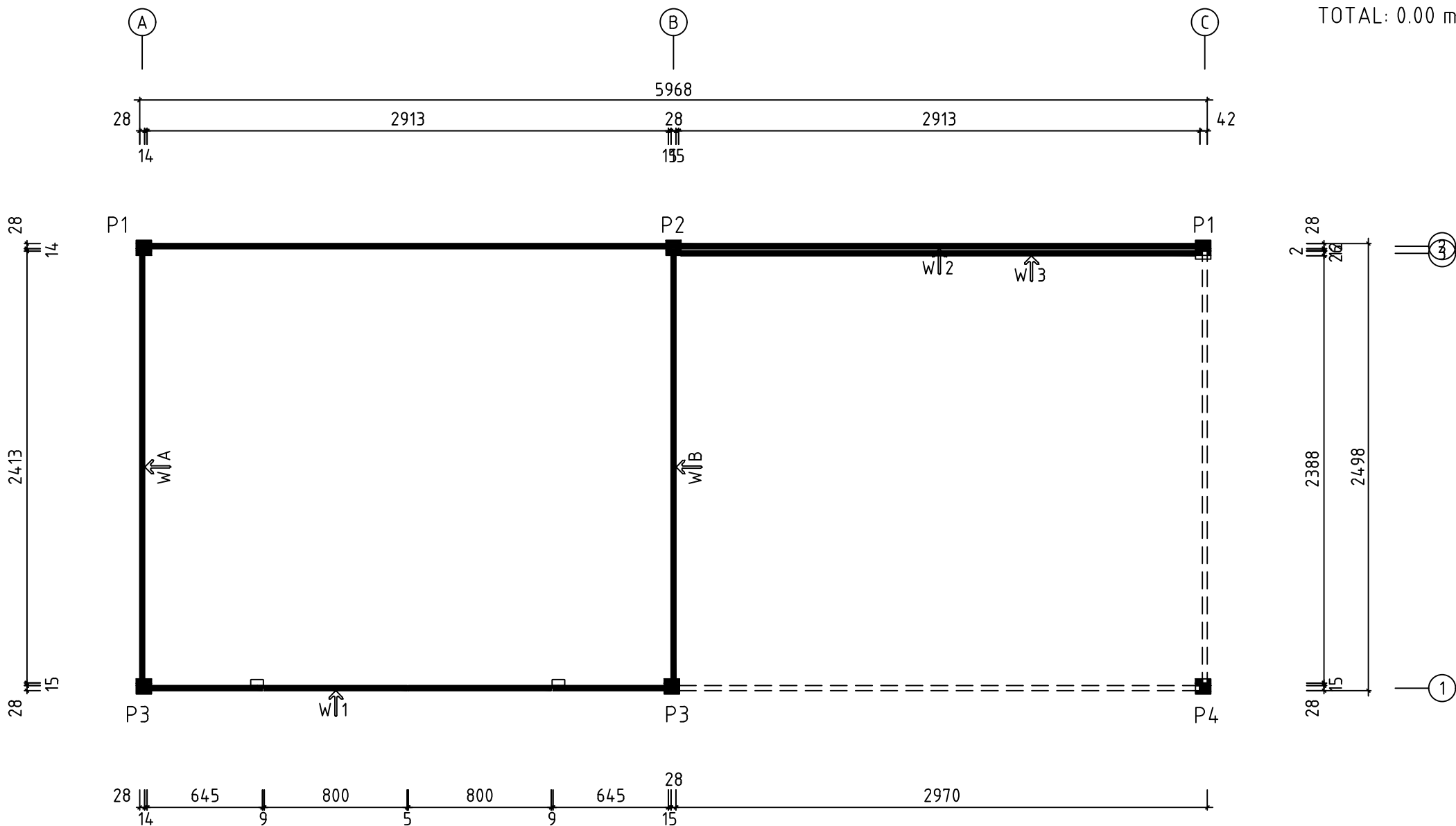

Model	Rosanne28	Page	PLAN
Client		Scale	1:30
Material	28x135mm	Date	13.12.2019
Company		File	Rosanne28.dwg

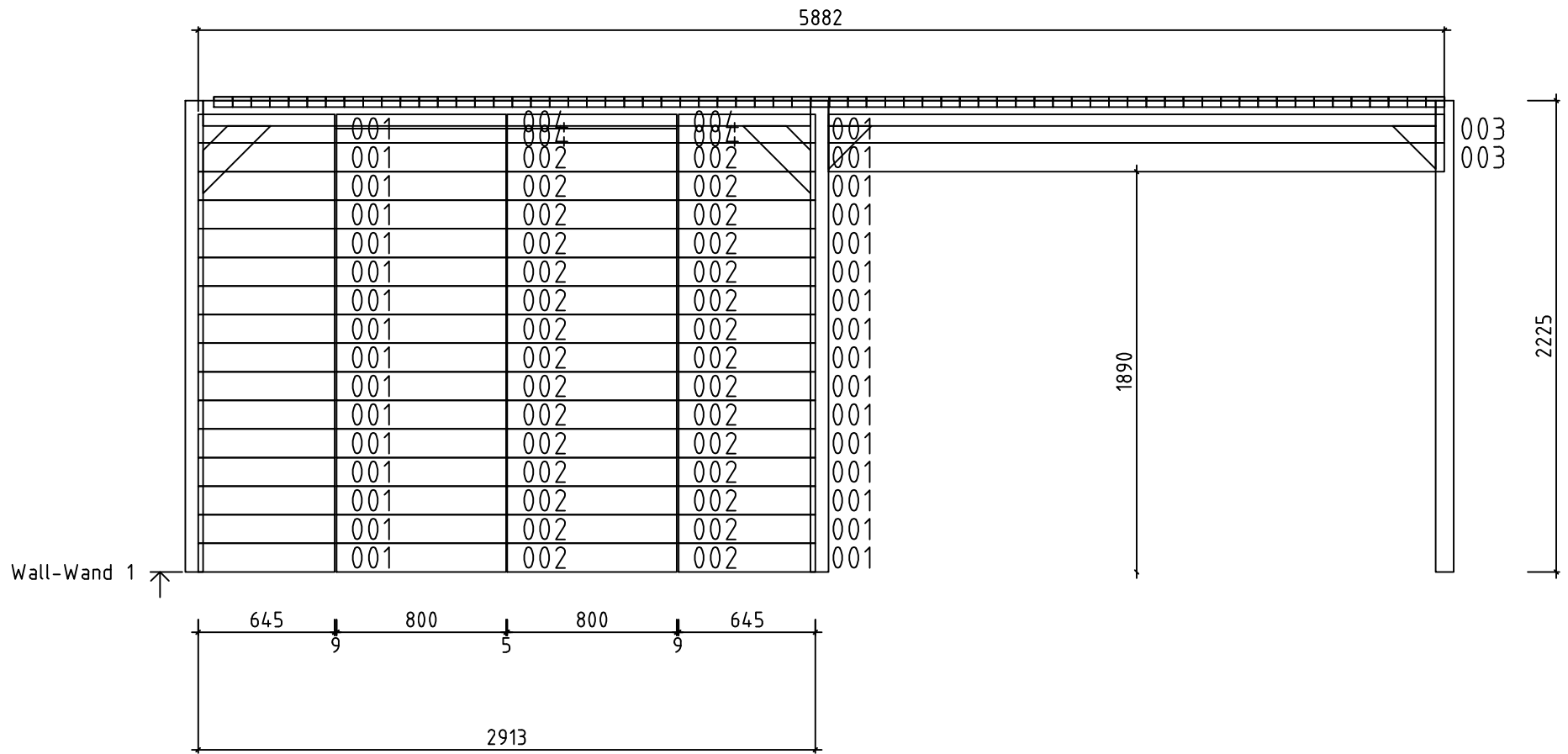

Model	Rosanne28	Page	5
Client		Scale	1:30
Material	2.8x13.5	Date	13.12.2019
Company		File	Rosanne28.dwg

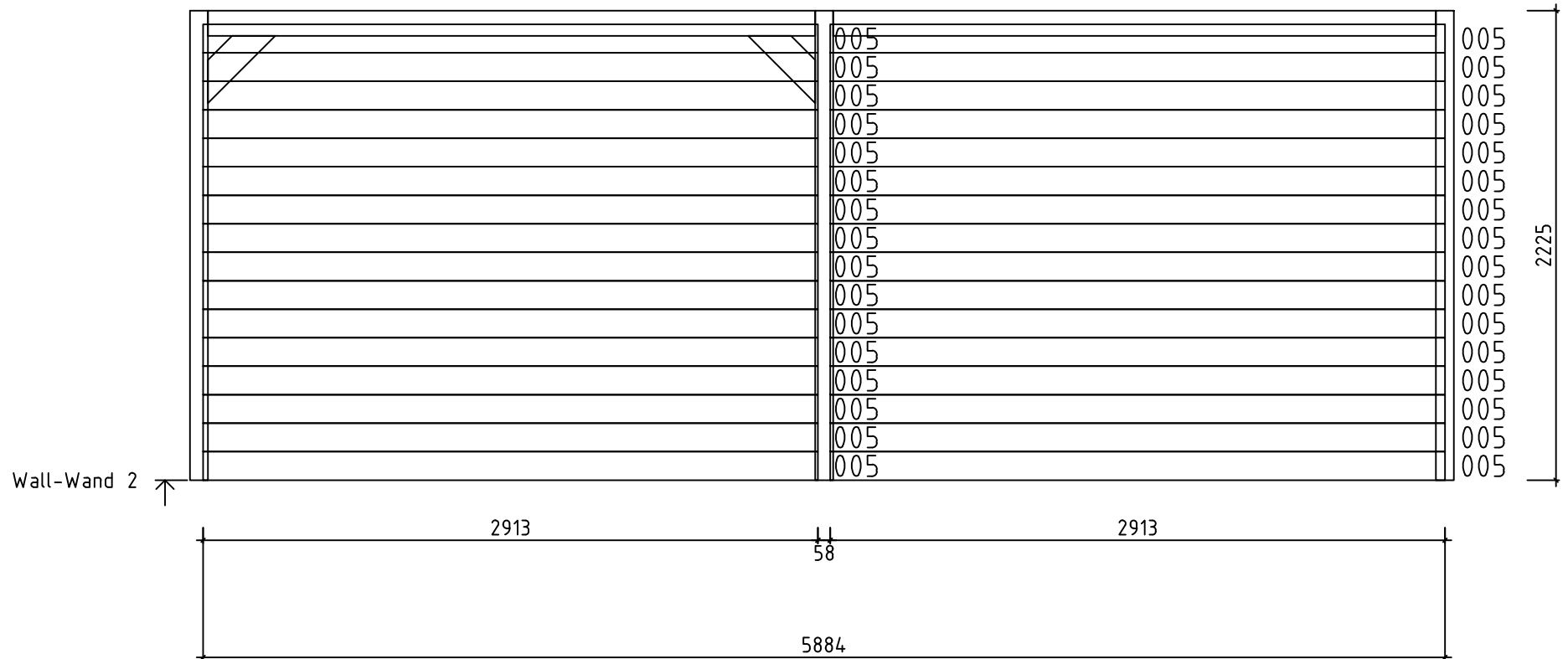

Model	Rosanne28	Page	6
Client		Scale	1:30
Material	2.8x13.5	Date	13.12.2019
Company		File	Rosanne28.dwg

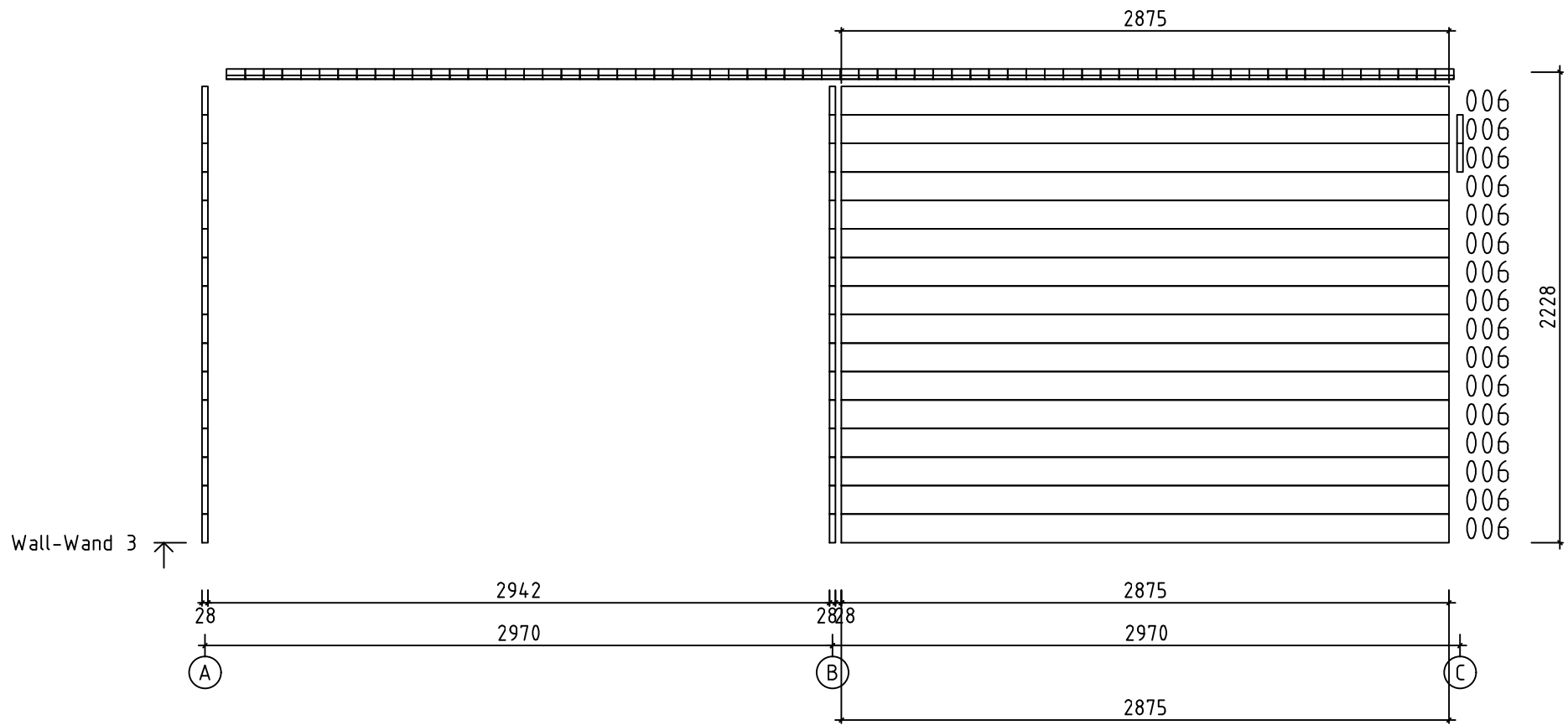

Model	Rosanne28	Page	7
Client		Scale	1:30
Material	2.8x13.5	Date	13.12.2019
Company		File	Rosanne28.dwg

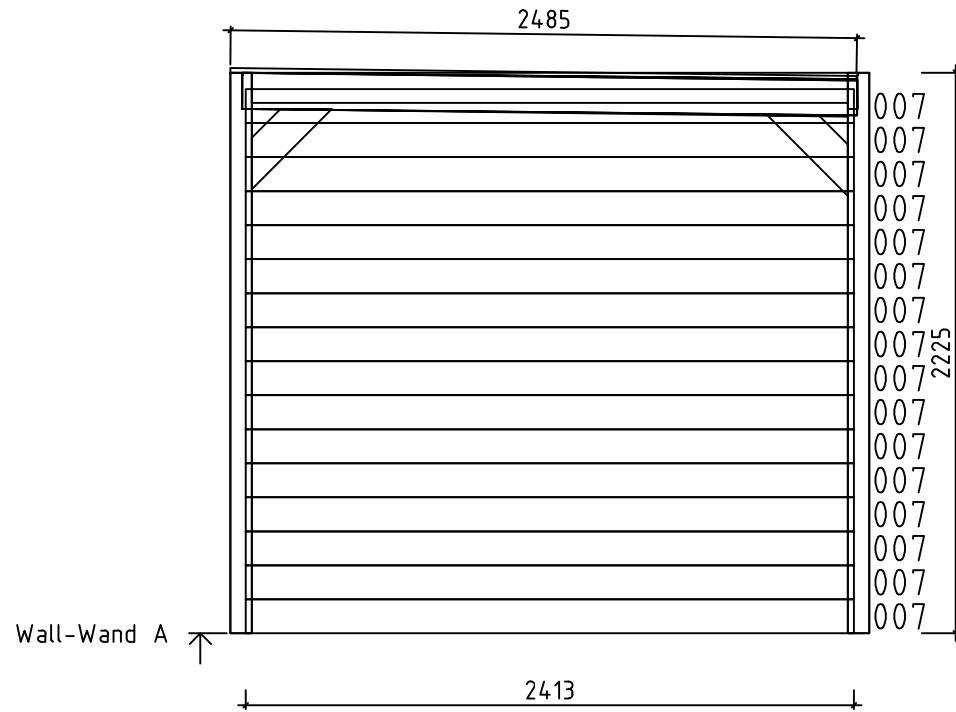

Model	Rosanne28	Page	2
Client		Scale	1:30
Material	2.8x13.5	Date	13.12.2019
Company		File	Rosanne28.dwg



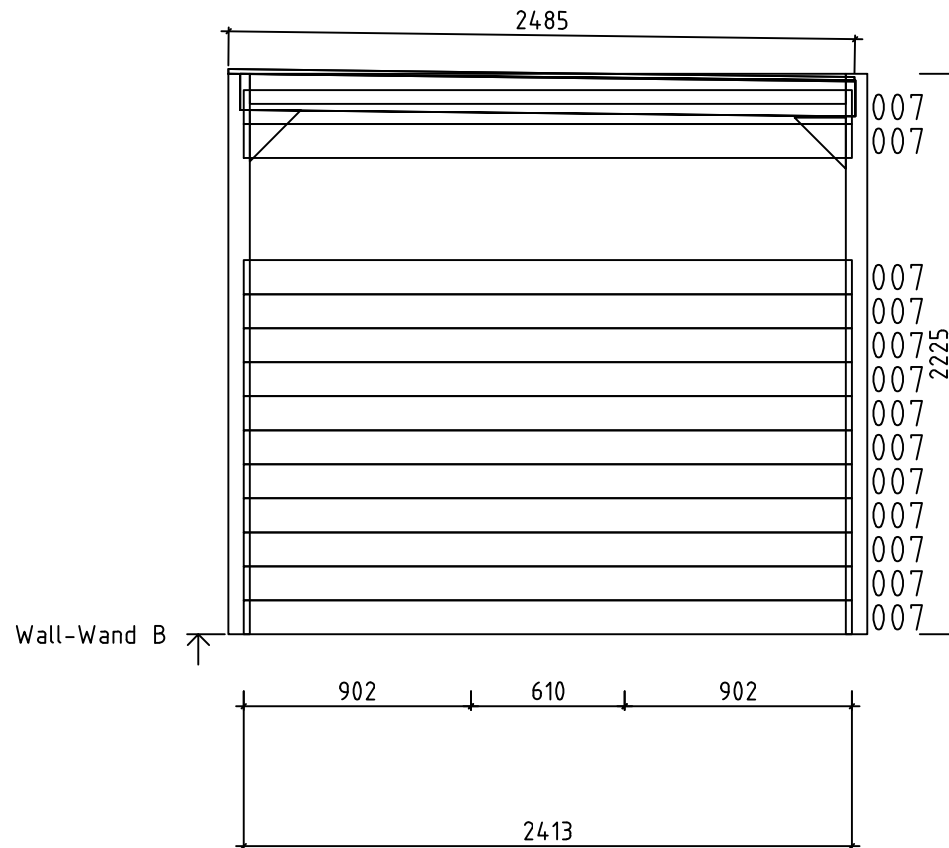

Model	Rosanne28	Page	3
Client		Scale	1:30
Material	2.8x13.5	Date	13.12.2019
Company		File	Rosanne28.dwg

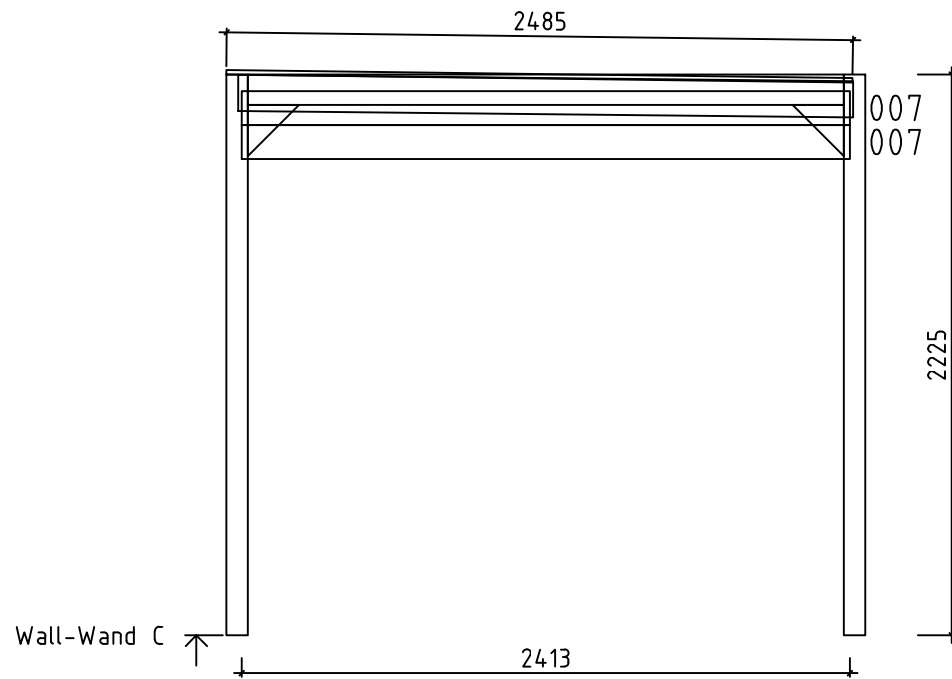

Model	Rosanne28	Page	4
Client		Scale	1:30
Material	2.8x13.5	Date	13.12.2019
Company		File	Rosanne28.dwg

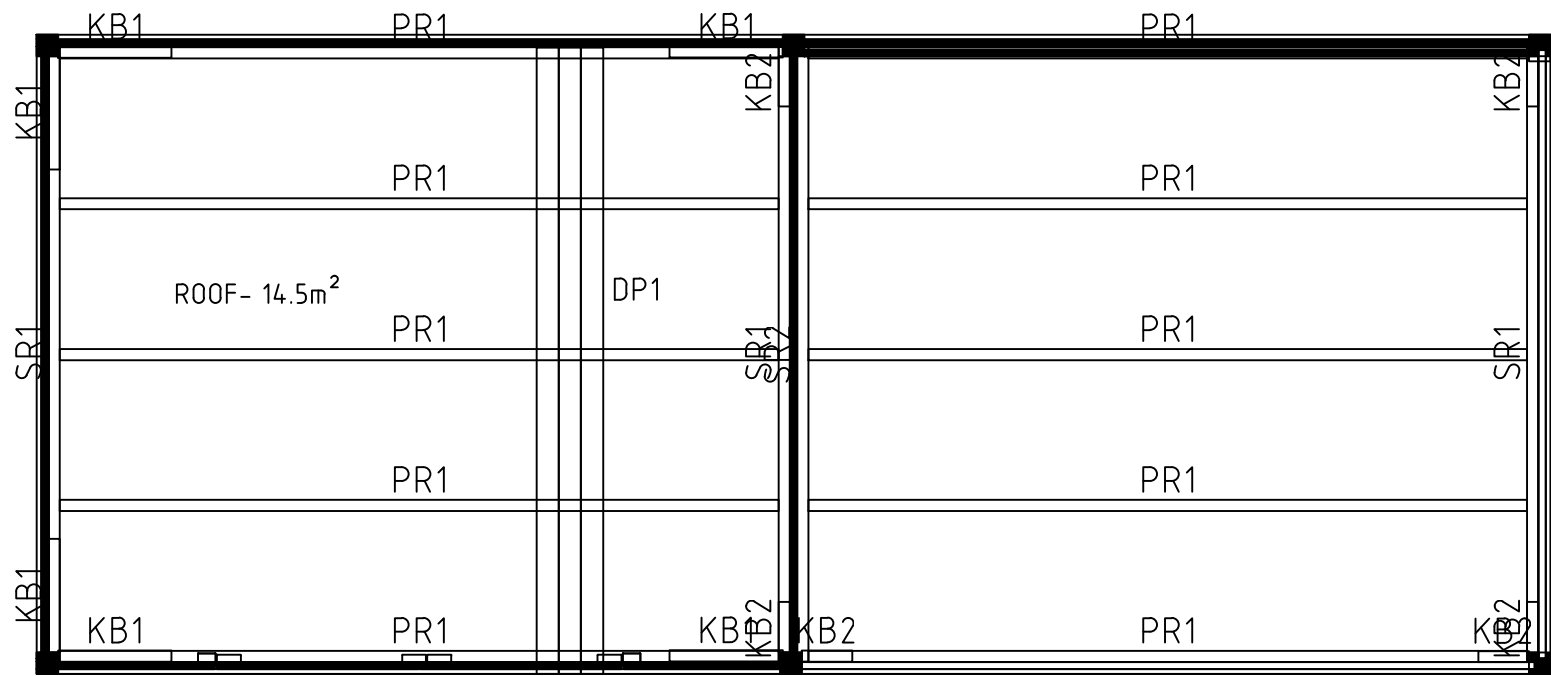

Model	Rosanne28	Page	ROOF
Client		Scale	1:30
Material	28x135mm	Date	13.12.2019
Company		File	Rosanne28.dwg